

The OLI logo is positioned in the upper right corner of the image. It features a stylized white 'O' with a small circle inside, followed by the letters 'LI' in a bold, sans-serif font. The background behind the logo is a textured, golden-brown wall with a decorative light fixture visible in the top right corner.

























































OLI



SANITARY SYSTEMS

2021 | 2022

PICTOGRAMS

- | | | | |
|---|---------------------------------------|---|---|
|  | Squat pan |  | OLIpure System |
|  | Solid wall, floor standing toilet |  | Hydroboost  |
|  | Solid wall, wall-hung toilet |  | Water efficiency certification |
|  | Solid wall, wall-hung washbasin |  | Economic |
|  | Solid wall, wall-hung urinal |  | 120mm thick |
|  | Drywall, wall-hung toilet |  | 126mm thick |
|  | Drywall, wall-hung urinal |  | 80mm thick |
|  | Drywall, wall-hung washbasin |  | 90mm thick |
|  | Solid wall (rails or urinal dividers) |  | 150mm thick |
|  | Drywall |  | 187mm thick |
|  | Supports up to 400kg |  | 190mm thick |
|  | Supports up to 150kg |  | Front or top actuation |
|  | Without maintenance |  | Reduced mobility |
|  | Stop Fire |  | 100% Hygienic |
|  | 2 inlet valves |  | Vandal resistance |
|  | SHT - Shower Toilet |  | Side water supply connection |
|  | 4/2 liters |  | Bottom water supply connection |
|  | Start/Stop flush |  | Anti-condensation lining |
|  | Dual flush |  | 2 years warranty |
|  | Single flush |  | 5 years warranty |
|  | Saves up to 9l of water per day |  | 10 years warranty |
|  | Mechanic actuation |  | 0.5mm thick |
|  | Pneumatic actuation |  | 2mm thick |
|  | Capacitive sensor |  | 4mm thick |
|  | Electronic actuation |  | Seawater |
|  | AC power-mains |  | Height ajustable |
|  | Happy Air |  | ColorADD |
|  | One man assembly | | |



OLIcare



Projects



Sustainable



Design



Renovation



Public Spaces

The symbols shown here are used throughout this catalogue to indicate the following features and benefits

PHOTOGRAPHY

OLI, freepick page 4 and page 193 Ivo Tavares Studio.

OLI



RESEARCH, DEVELOPMENT AND INNOVATION



COMPANY PRESENTATION



FROM PORTUGAL TO THE WORLD

OLI is the biggest manufacturer of flushing mechanism in South Europe and partner to the main worldwide players of ceramic sanitary ware.

The company was raised in Aveiro in 1954, in the center region of Portugal. From its wide and modern industrial complex, recognized by its productive efficiency, OLI exports 80% of its production to over 80 countries in the five continents.

Today, OLI is a global brand that can be found in bathrooms all over the world. From a luxurious hotel in Dubai to a modern hospital in Israel, from the new football stadium in Qatar to the tourist restaurant in Italy, OLI bets on the customization of its product to answer the requirements of each market, as well as obtaining diverse international certifications to authenticate the quality and safety of its solutions in the geographies in which it is present.

INNOVATION IN THE BRAND DNA

OLI factory never sleeps. Daily its Research and Investigation Center studies new solutions, hydraulically efficient for a comfortable and inclusive bathroom.

Innovation defines its DNA and its signature "Inspired by Water" - which expresses OLI mission to place innovation in the service of water preservation, with the goal of defending this scarce natural resource in which, life on this planet depends on. The dual flush mechanism (1994), which contributed to the reduction of 50% of water, was its first innovation project. The mass production of this solution brought a tremendous environmental and economic benefit at a world scale.

To this invention, many other simple solutions joined, that have transformed our vision and experience of the bathroom space.

OLI is one of the Portuguese enterprises that most patents in Europe, with 34 active patents at the moment. This strategy of value creation, of focus on the knowledge and innovation culture was recognized with many awards - Millennium Horizontes, Good Design, Iconic Awards, Design Plus and IF Design.

DESIGN AND AUTHOR IDENTITY

From inlet valves that assure a quick and silent filling of the tank, to resistant frames structures that allow the user to adjust the height of the sanitary, to the flush plates designed by world renowned architects, OLI as built a valuable portfolio, where innovative cisterns assume a natural protagonism.

With resource to patent technology and to the high standards of quality in the manufacturing, the brand presents products to apply in projects of new construction, rehabilitation, renovation, that stand out for its contemporary design, and usage of nobles' materials and functionality. In the last years, OLI has invested more in its relation with the Architectural field, building new partnerships with names such as Álvaro Siza Viera (Pritzker Award 1992), Eduardo Souto de Moura (Pritzker Award 2011), Romano Aldolini and Alessio Pinto, that applied their talent in the creation of unique pieces for the brand.

OLI fullfills its vision: being a company of recognized excelency for its innovation and value creation for all.

OLI IN NUMBERS

Sales Volume
60.2 million euros

PRODUCTION VOLUME

2 million cisterns
2.8 million flushing mechanism
144 million injected components

INTERNATIONALIZATION

80 markets

COMMERCIAL BRANCHES

4 (Spain, Germany, Italy and Russia)

PATENTS

38

EMPLOYEES

419

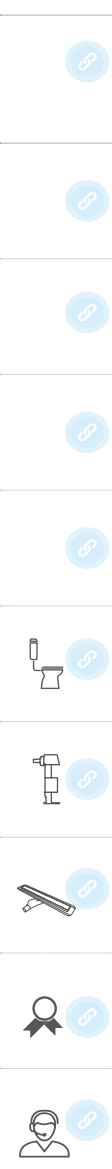

INDEX

SANITARY MODULES
Page 08



IN-WALL CISTERNS
Page 38

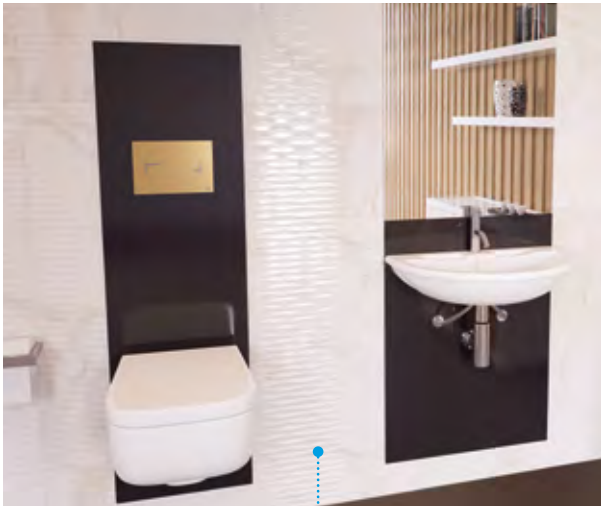
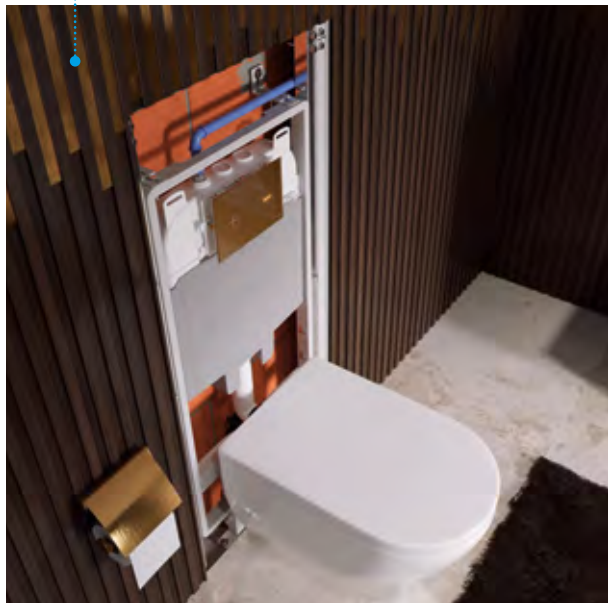

EASY MOVE
Page 24



FRAMES
Page 124

FLUSH PLATES
Page 148



EXPOSED
FLUSH CISTERNS
Page 218



MECHANISMS
Page 232



OLIFILO
Page 258



WARRANTY
Page 272



OLI SERVICES
Page 274





878641
QR-INOX Black no-touch cap AC hung wc

Best solution for a
quick renovation or
a new modern
bathroom project.

SANITARY MODULES

THE PRESENT OF BATHROOM IMPROVEMENT



Design



Renovation

The QR-INOX, QR TOTAL and the SEAL BOX for wall hung and floor mounted toilets, emerge thinking of those who wish to renovate their bathroom without resorting to profound construction work or for those fond for the design in every house division!

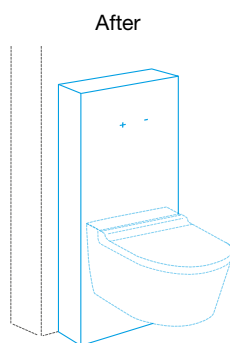
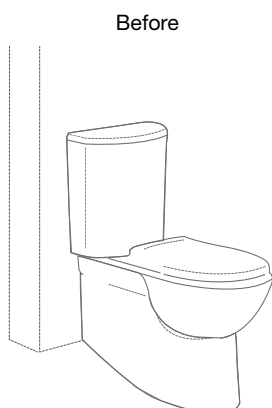

GOOD REASONS TO REDESIGN THE BATHROOM

- Walls do not need to be open for installation;
- Existing water connections can be used;
- A modern design in every bathroom.

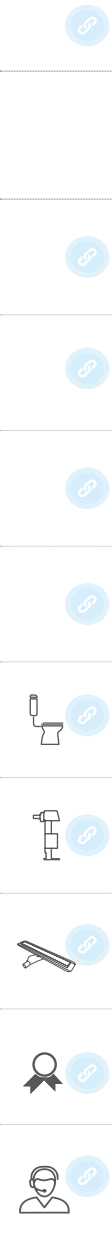



878141
QR TOTAL Black button Pneumatic hung wc

SANITARY MODULES

10

10 YEAR WARRANTY

5 POSSIBLE WATER CONNECTIONS

Multiple water connections allow a higher adaptability to the installation requirement



FLUSH VOLUME

Dual flush: 6/3 litres.
Adjustable to 4.5/3 litres

SILENT VALVE
Class 1 certified



PLUS
Delayed refill system



NO-TOUCH

With No-Touch technology there is no need to touch the module to activate the flush. Hygiene and convenience are taken to a new level, by adopting a clean and sustainable technology

HYDROBOOST

AC POWER-MAINS



PNEUMATIC

The pneumatic version comes with a stainless steel tilt selector button in a matt finish for activation the flush

STAINLESS STEEL EDGE

One piece, brushed stainless steel frame

400 kg

SUPPORTS UP TO 400KG

FINISHINGS

Tempered glass with multiple colour options available

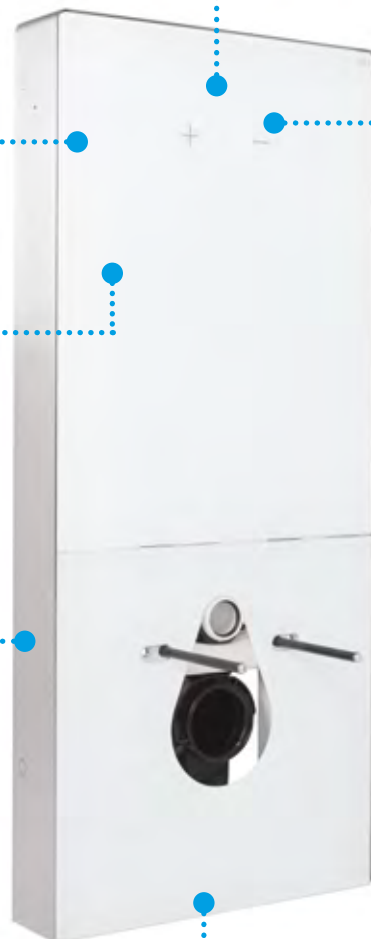

FOR BATHROOM IMPROVEMENTS



QR-INOX and QR TOTAL

QR-Inox and QR Total are part of the sanitary module range, a universal and versatile solution to upgrade the look of the bathroom.



NO-TOUCH VERSION

There are two distinct power options: Hydroboost and AC technology. Hydroboost is an OLI innovation, it is a self-sustaining system in which the activation of the flush generates its own energy and therefore doesn't use a source of electricity or batteries. The flush is activated with the approach of the hand, without touching the module, thanks to the use of capacitive sensors. The AC version, is the other No-Touch solution that OLI offers, with connection of the sensors to the power grid, allowing the flush to be activated with the approach of the hand.



PNEUMATIC VERSION

Comes with a stainless steel tilt selector button in a matt finish for activating the half flush and the complete flush. The button's rounded shape provides the sanitary modules with nobility and distinctiveness.



Design



Renovation



STAINLESS STEEL

The edge around the sanitary modules is made of one piece brushed stainless steel with the following finishes: brushed (QR-Inox), black or white coated (QR Total).



FLOOR

QR-Inox Floor and QR Total Floor are compatible with all floor mounted toilets available in the market.



HUNG WC

QR-Inox Hung WC and QR Total Hung WC are compatible with all wall hung toilets available in the market*.



FREE-STANDING

This product is specially indicated for wall-hung toilets in any type of wall (masonry and plasterboard), since this highly robust frame is only attach to the floor.

* Not compatible with 4 fixation point toilets.

A suitable answer for those who are septic of the easiness of access and mantainance of the in-wall cistern.



880450
SEAL BOX Black button Pneumatic hung wc



Design



Renovation

SEAL BOX

A new flushing cistern concept that carries design to the bathroom space with its frontal glass.

The SEAL BOX is a differentiator in-wall cistern as it embodies a full back box, to protect any water leakage or infiltration. It's lined with a tempered glass, available in white or black. The SEAL BOX is available in No-Touch (Hydroboost or AC technology) or Pneumatic actuation.



IN-WALL CISTERNS INTERIOR ACCESS

The in-wall cisterns improve the space and hygiene in a bathroom.

The SEAL BOX comes to demystify the access to in-wall cisterns inside of the Wall, with its main advantage being the easiness of the access to the in-wall cistern.



NO-TOUCH

Hygiene is taken to a higher level. OLI creates a clean and sustainable technology: Hydroboost.



PNEUMATIC

The button's rounded shape provides the sanitary modules with nobility and distinctiveness.

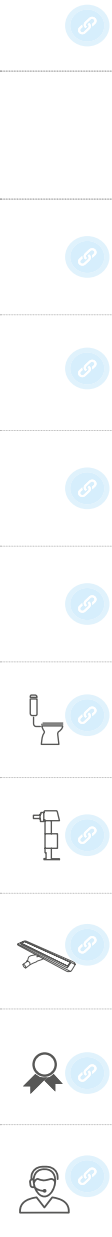

TECHNICAL INFORMATION

SEAL BOX

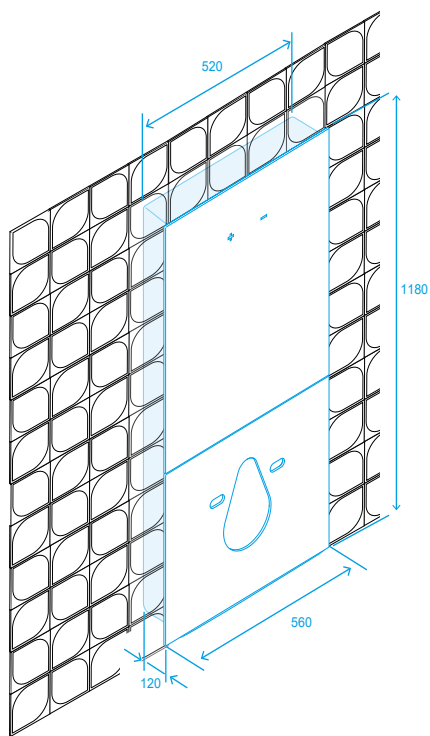

QR-INOX AND QR TOTAL

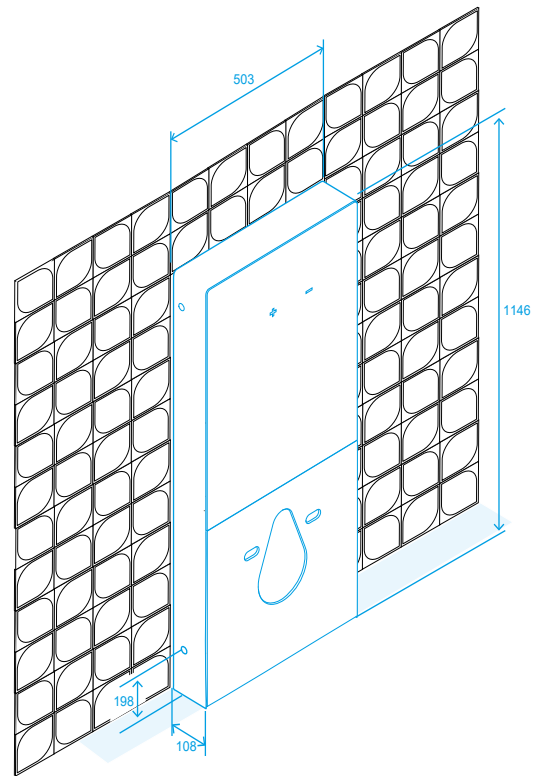

SEAL BOX

The installation in solid wall, requires to tear the wall to built-in the involving box.

The installation in technical frames, also demands that the box of Seal Box to be built-in, however the space between the frames must be safeguarded.

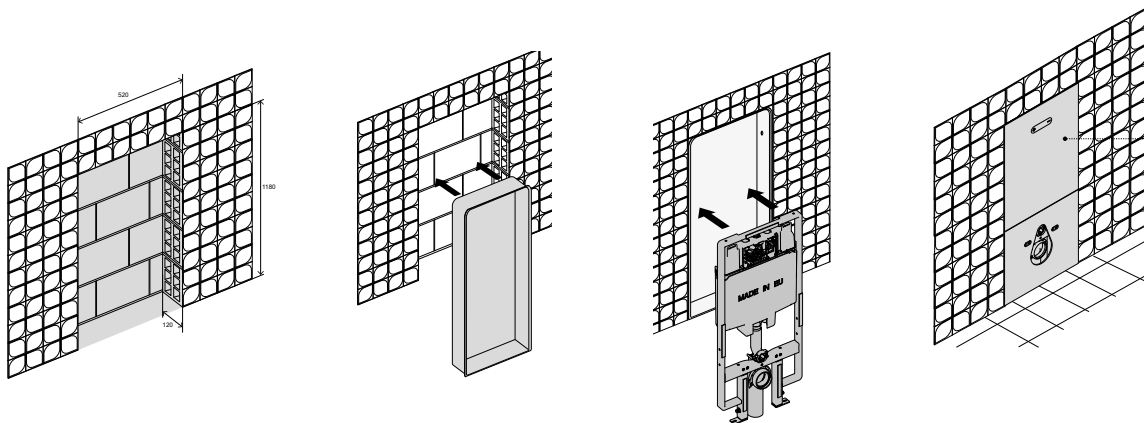

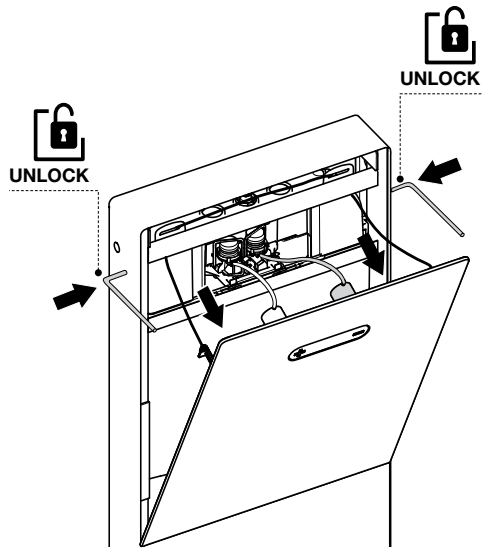

EASY MAINTENANCE

For an easy maintenance, the sanitary module brings two keys to insert in the small side holes to open and access the cistern.

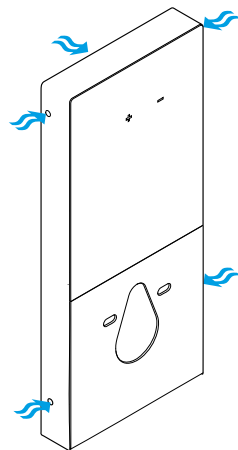

5 WATER CONNECTION ENTRIES

One of the advantages of OLI sanitary modules are the compatibility with all bathrooms, even the older ones, by possessing 5 water connection entries.

QR-INOX AND QR TOTAL

QR-Inox and QR Total are sanitary modules that adapt to many locations and were designed for a greater space saving in any bathroom. Taking advantage of the existing water connections and waste pipe already in the bathroom, this range of sanitary modules are the perfect solution for a modern bathroom, without any requirement for a profound construction work.

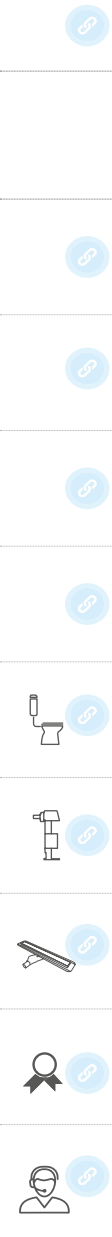
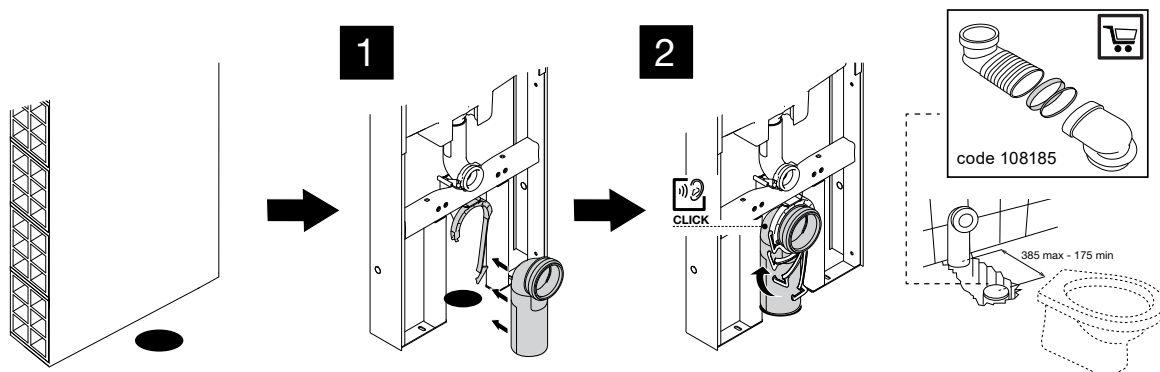

QR-INOX

Hung WC

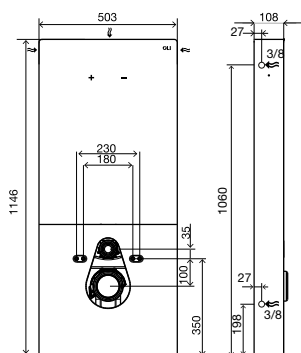

GENERAL FEATURES

- Dual flush Sanitary Module 6/3 litres;
- Compatible with all wall-hung toilets;
- Delayed refilling – PLUS technology inlet valve;
- 108mm thick;
- Equipped with OLI74 PLUS cistern;
- Outlet bend and Ø90/110 adaptor;
- Toilet fixing material;
- EN 14055 CE marking;
- Global warranty of 10 years and 2 years on the electronic components.

QR-INOX

Free Standing

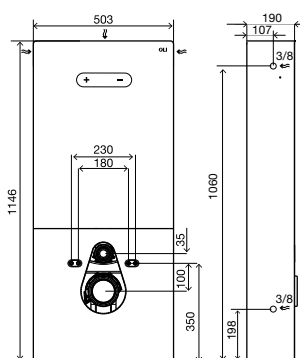

GENERAL FEATURES

- Dual flush Sanitary Module 6/3 litres;
- Compatible with all wall-hung toilets ;
- Delayed refilling – PLUS technology inlet valve;
- 190mm thick;
- Equipped with OLI74 PLUS cistern;
- Outlet bend and Ø90/110 adaptor;
- Toilet fixing material;
- EN 14055 CE marking;
- Global warranty of 10 years and 2 years on the electronic components.

QR-INOX

Floor

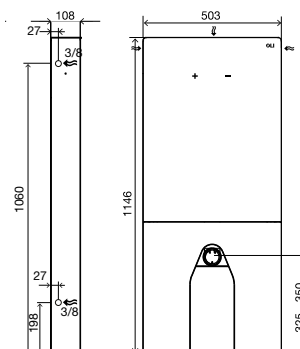

GENERAL FEATURES

- Dual flush Sanitary Module 6/3 litres;
- Compatible with all floor mounted toilets;
- Delayed refilling – PLUS technology inlet valve;
- 108mm thick;
- Equipped with OLI74 PLUS cistern;
- Flexible outlet WC (min 220 to 570mm);
- EN 14055 CE marking;
- Global warranty of 10 years and 2 years on the electronic components.

INCLUDED IN ALL VERSIONS

- Internal frame fixing material;
- Inlet and outlet toilet connection;
- G 1/2" stop valve;
- Flexible hose 1/2" / 3/8", 250mm.



QR TOTAL

Hung WC

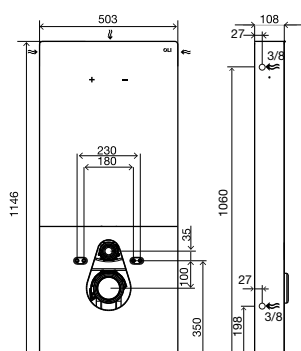

GENERAL FEATURES

- Dual flush Sanitary Module 6/3 litres;
- Compatible with all wall-hung toilets;
- One piece, brushed stainless steel lateral frame, black or white coated;
- Delayed refilling – PLUS technology inlet valve;
- 108mm thick;
- Equipped with OLI74 PLUS cistern;
- Outlet bend and Ø90/110 adaptor;
- WC pan fixing material;
- EN 14055 CE marking;
- Global warranty of 10 years and 2 years on the electronic components

INCLUDED IN ALL VERSIONS

- Internal frame fixing material;
- Inlet and outlet toilet connection;
- G 1/2" stop valve;
- Flexible hose 1/2" / 3/8", 250mm.

QR TOTAL

Floor

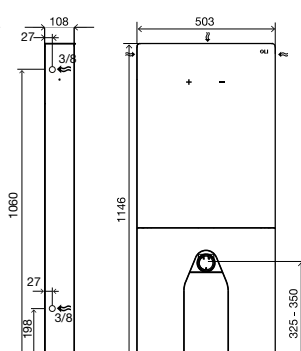

GENERAL FEATURES

- Dual flush Sanitary Module 6/3 litres;
- Compatible with all floor mounted toilets;
- One piece, brushed stainless steel lateral frame, black or white coated;
- Delayed refilling – PLUS technology inlet valve;
- 108mm thick;
- Equipped with OLI74 PLUS cistern;
- Flexible outlet WC (min 220 to 570);
- EN 14055 CE marking;
- Global warranty of 10 years and 2 years on the electronic components.

SEAL BOX

Hung WC

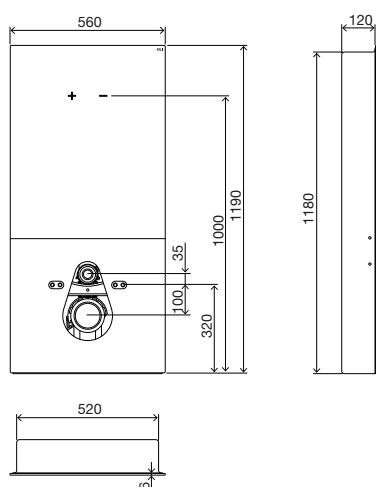

GENERAL FEATURES

- In-wall installation with glass front panel visible;
- Leakage prevention box in ABS and PMMA;
- Dual flush Sanitary Module 6/3 litres;
- Compatible with all wall-hung toilets;
- Solid and drywall installations;
- Delayed refilling – PLUS technology inlet valve;
- 120mm thick;
- Equipped with OLI74 PLUS cistern;
- Outlet bend and Ø90/110 adaptor;
- Toilet fixing material;
- EN 14055 CE marking;
- Global warranty of 10 years and 2 years on the electronic components.

SEAL BOX

Floor

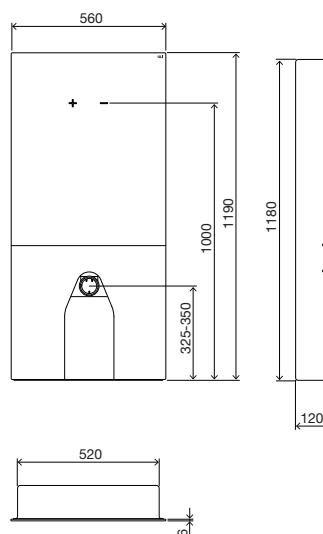

GENERAL FEATURES

- In-wall installation with glass front panel visible;
- Leakage prevention box in ABS and PMMA
- Dual flush Sanitary Module 6/3 litres;
- Compatible with all floor mounted toilets;
- Solid and drywall installations;
- Delayed refilling – PLUS technology inlet valve;
- 120mm thick;
- Equipped with OLI74 PLUS cistern;
- Flexible outlet WC (min 220 to 570mm);
- EN 14055 CE marking;
- Global warranty of 10 years and 2 years on the electronic components.

INCLUDED IN ALL VERSIONS

- Internal frame fixing material;
- Inlet and outlet toilet connection;
- G 1/2" stop valve;
- Flexible hose 1/2" / 3/8", 250mm.

ACCESSORIES



S-BEND OUTLET TOILET

- Length 175mm to 385mm;
- Exit Ø90/110;
- Toilet connection Ø90.

CODE	DESCRIPTION
108185	S-Bend outlet



OUTLET BEND ADAPTOR Ø90/110

- Polypropylene (PP) material;
- Adaptor to match with Ø90/110.

CODE	DESCRIPTION
086360	PP Adaptor Ø90/110



FLEXIBLE OUTLET BEND TOILET

- Length 220mm to 570mm;
- Exit Ø90/110;
- Toilet connection Ø80/100.

CODE	DESCRIPTION
079929	Flexible outlet Bend



HORIZONTAL OUTLET TOILET

- Length 300mm;
- Exit Ø110;
- Toilet connection Ø90.

CODE	DESCRIPTION
108380	Horizontal outlet toilet



ECCENTRIC 20MM

- Hight 118mm;
- Exit Ø100;
- Toilet connection Ø90/110.

CODE	DESCRIPTION
881608	Eccentric offset pipe 20mm







ECCENTRIC 40MM

- Hight 125mm;
- Exit Ø110;
- Toilet connection Ø90/110.

CODE	DESCRIPTION
881613	Eccentric offset pipe 40mm

PART NUMBER GUIDE

MODEL 	 Pneumatic	 Hydroboost	 Cap AC
QR-INOX White □	061565 Hung wc 879059 Free-standing 061562 Floor	878815 Hung wc 879061 Free-standing 878835 Floor	878640 Hung wc 879151 Free-standing 878642 Floor
QR-INOX Black ■	061568 Hung wc 879060 Free-standing 061563 Floor	878834 Hung wc 879062 Free-standing 878836 Floor	878641 Hung wc 879152 Free-standing 878643 Floor
QR-INOX Taupe ✖	878164 Hung wc	-	-
QR-INOX Gold ■	878137 Hung wc	-	-
QR-INOX Anthracite ■	878168 Hung wc	-	-
QR-INOX Red ■	878172 Hung wc	-	-
QR TOTAL White □	878152 Hung wc 878150 Floor	878153 Hung wc 878151 Floor	878633 Hung wc 878632 Floor
QR TOTAL Black ■	878141 Hung wc 878139 Floor	878147 Hung wc 878140 Floor	878631 Hung wc 878630 Floor
SEAL BOX White □	880372 Hung wc 880455 Floor	880451 Hung wc 880457 Floor	880453 Hung wc 880459 Floor
SEAL BOX Black ■	880450 Hung wc 880456 Floor	880452 Hung wc 880458 Floor	880454 Hung wc 880460 Floor

WxDxH	Weight	Qt.	Multiple Box Dim	Weight	Qty per Pallet	Pallet Height	Pallet Width	Pallet Length	Weight
1185x545x282	27.21	-	-	-	5	1.57	0.8	1.2	164.25
1200x545x380	30	-	-	-	4	1.57	0.8	1.2	144.88
1185x545x282	23.46	-	-	-	5	1.57	0.8	1.2	145.15
1185x545x282	27.21	-	-	-	5	1.57	0.8	1.2	164.25
1200x545x380	30	-	-	-	4	1.57	0.8	1.2	144.88
1185x545x282	23.46	-	-	-	5	1.57	0.8	1.2	145.15
1185x545x282	27.21	-	-	-	5	1.57	0.8	1.2	164.25
1185x545x282	27.21	-	-	-	5	1.57	0.8	1.2	164.25
1185x545x282	27.21	-	-	-	5	1.57	0.8	1.2	164.25
1185x545x282	27.21	-	-	-	5	1.57	0.8	1.2	164.25
1185x545x282	27.21	-	-	-	5	1.57	0.8	1.2	164.25
1185x545x282	23.46	-	-	-	5	1.57	0.8	1.2	145.15
1185x545x282	27.21	-	-	-	5	1.57	0.8	1.2	164.25
1185x545x282	23.46	-	-	-	5	1.57	0.8	1.2	145.15
1206x601x282	23.76	-	-	-	5	1.57	0.8	1.2	146.1
1206x601x282	23.76	-	-	-	5	1.57	0.8	1.2	146.1
1206x601x282	23.76	-	-	-	5	1.57	0.8	1.2	146.1
1206x601x282	23.76	-	-	-	5	1.57	0.8	1.2	146.1

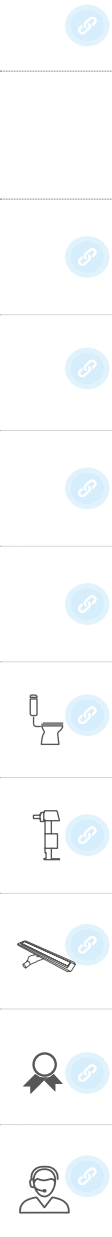



OLIcare



Design

EASY MOVE RANGE

ELEGANT MOVEMENT REDEFINED

Committed to developing a safe and comfortable bathroom for all, OLI has several solutions designed for people with reduced mobility, the elderly and children.

The Easy Move range was developed to facilitate the day-to-day at home, in nursing homes, hospitals or commercial spaces (airports, commercial centers).

GOOD REASONS TO REDEFINE THE BATHROOM

- It offers a solution that is both aesthetically pleasing and highly functional that allows the user to vary the height of a toilet using a remote control.
- Easy Move WC: The frame moves the toilet up to 150mm with the user seated.
- Easy Move Washbasin: The frame moves the washbasin up to 300mm.



DESIGN
AWARD
2020

EASY MOVE RANGE GIVES OLI THE OSCAR OF WORLD DESIGN

OLI won the IF Design Award 2020, considered the Oscar of world design, in the bathroom category. This distinction recognizes the continuous bet in innovation and design.







884481
Black glass plus mirror

881673
Easy Move Washbasin

EASY MOVE WASHBASIN

Adjustable frame

10*

10 YEAR WARRANTY



FAST-FIT SYSTEM
Allows a quick and easy adjustment.

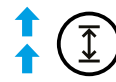

ERGONOMIC SYSTEM
Adjustable in height by 300 mm.

150 kg

SUPPORTS UP TO 150KG

INSTALLATION SYSTEM

Solid wall-brick lined,
and all wall-hung toilets



Dry wall,
and all wall-hung toilets



FLEXIBLE OUTLET PIPE

Flexible pipe that accompanies the adjustment of the height of the sink.

HIDEN SIPHON

Guarantees easy access for maintenance.



WIRELESS REMOTE ACTUATION



Comfort to care!



WIRELESS REMOTE CONTROL

Easy Move Washbasin allows the user to adjust the height of the washbasin (up to 300mm), using a wireless remote control.



EASY MOVE WASHBASIN

With the pass of the years, it becomes more important that the house spaces adapt to the different practical necessities of our day-to-day. The Easy Move Washbasin is an aesthetic pleasant solution that comes to make the bathroom space more accessible and safe to all.

This product is compatible with all suspended washbasins and allows the user to adjust the height of the washbasin, starting with a minimum of 660mm and reaching a maximum height of 960mm.





FINISHES AVAILABLE

The product is available in both black and white tempered glass with 6mm of thickness.



CONCEALED SIPHON

For washbasin hidden connections $\varnothing 32$, this concealed siphon guarantees the maintenance access through magnets.



SILENT

The engine exerts a lifting force and the sound of the engine being almost imperceptible during operation. The movement speed is 28mm per second, allowing the washbasin to move quickly along the frame.





021409
EASY MOVE glass White

048159
EASY MOVE

EASY MOVE WC

Adjustable frame

10

10 YEAR WARRANTY



FAST-FIT SYSTEM

Allows a quick and easy adjustment.

NO-TOUCH

Wide range of flush plates and actuations: mechanical, pneumatic, electronic and No-Touch

SUPPORTS UP TO 400KG



INSTALLATION SYSTEM

Solid wall-brick lined, and all wall-hung toilets



Dry wall, and all wall-hung toilets



FINISHINGS

Tempered glass available in white or black

SUPPORT BARS

Product is already prepared to receive support bars

FLEXIBLE OUTLET PIPE

Flexible pipe that accompanies the adjustment of the height of the toilet.

WIRELESS REMOTE ACTUATION





EASY MOVE WC

When simple movements such as getting up from sitting on the toilet become a problem, Easy Move WC intervenes. This product is compatible with wall-hung toilets up to 660mm long and allows the user to adjust the height of the toilet, starting with a minimum of 400mm and reaching a maximum height of 550mm.

Easy Move WC comes to suppress the main obstacles and needs on the daily use of the bathroom, making it an inclusive solution, autonomous and safe.

FINISHES AVAILABLE

The product is available in both black and white tempered glass.



FLEXIBLE OUTLET BEND

This is the component responsible for connecting the Easy Move to the sewer. Made of EPDM, a resistant plastic to the continuous wear, with a width of 150mm.



SILENT

The engine exerts a lifting force and the sound of the engine being almost imperceptible during operation. Also the engine is extremely powerful with a thrust of more than 600kg offering maximum reliability. The movement speed is of 28mm per second, allowing the toilet to move quickly along the frame.



2014 Innovation Award about technologies to support building rehabilitation (Portugal)



SUPPORT BARS

For a daily and safe usage, the support bars are directly connected to the frame of the Easy Move WC. Developed in stainless steel and available in white or chrome, the support bars provide safety during the movements during the usage of the toilet.



WIRELESS REMOTE CONTROL

Easy Move WC allows the user to adjust the height of the toilet (up to 150mm), using a wireless remote control.

Compatibility

Wide range of flush plates



Moon



Glam



Metal



Ria Stop



Plain



Blink



Salina



Electra I



eLine



Glassy



Narrow



Ino-x



Ria



iPlate



Tribe



Globe



Slim



Oceania



Trumpet



Oceania



Trend

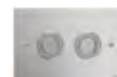

Electra II



Electra III



TECHNICAL INFORMATION

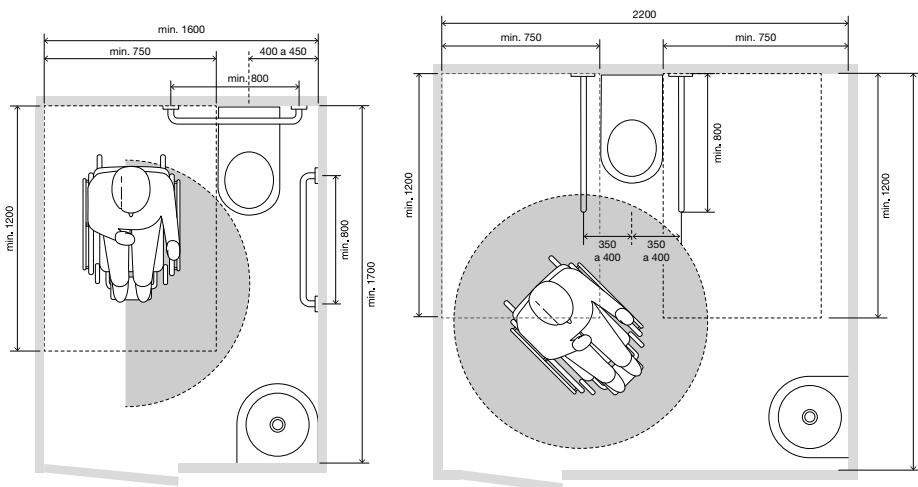
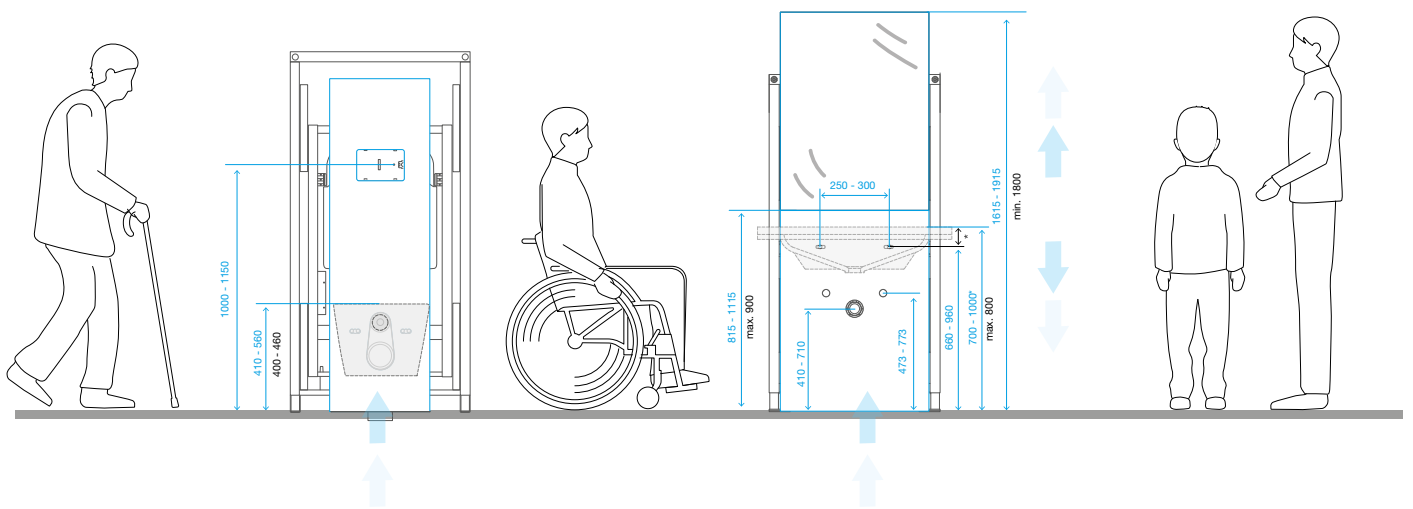

MINIMUM DIMENSIONS REQUIRED FOR THE INSTALLATION OF THE EASY MOVE WC

EASY MOVE

WC

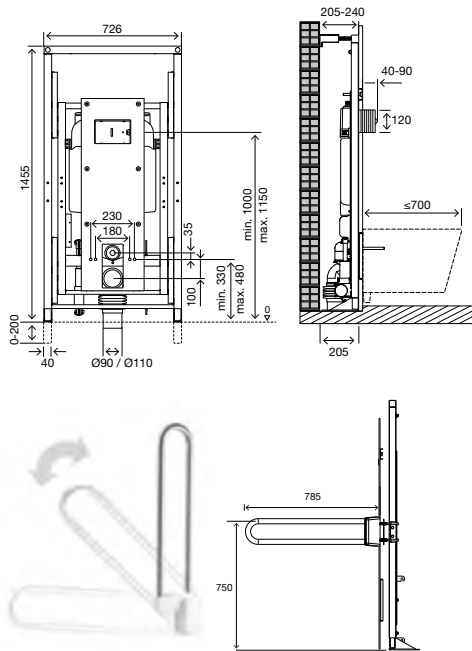

GENERAL FEATURES

- Adjustable frame with OLI74 PLUS dual flush cistern 6/3 litres;
- Ergonomic system that is adjustable in height by 150mm;
- Silent electric engine;
- Mains supply: 220V/110 (50/60Hz);
- Power: 350 Watt;
- Insulation rating: IP66;
- Movement velocity of: 28mm/s;
- Push power: 6000N (ca 600kgf);
- Traction power 3000N (ca 300kgf);
- Limit switch;
- Frame tested for a 400kg load;
- Easy and quick installation with fast fit system;
- Available tempered glass front cover in black or white (6x400x1345mm);
- Frame and glass are sold separately;
- Flush plate not included;
- Global warranty of 10 years and 2 years on the electronic components.

INCLUDED

- Wireless remote control;
- Wall-fixing material and toilet fixing material;
- Inlet and outlet toilet connection.

EASY MOVE

Washbasin

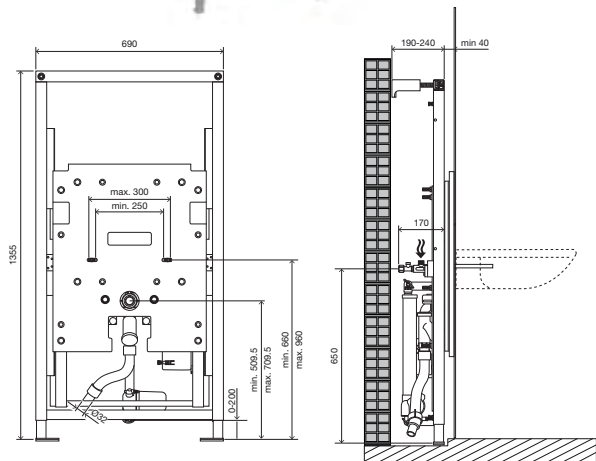

GENERAL FEATURES

- Adjustable frame for washbasin;
- Ergonomic system that is adjustable in height by 300mm;
- Compatible with the most wall hung washbasins;
- Silent electric engine;
- Mains supply 220V/110 (50/60Hz);
- Power: 350 Watt;
- Insulation rating: IP66;
- Movement velocity: of 28mm/s;
- Push power: 6000N (ca 600kgf);
- Limit switch;
- Frame tested for a 150kg load;
- Easy and quick installation with fast fit system;
- Available tempered glass front cover in black or white (6x700x810mm);
- Frame and glass are sold separately;
- Global warranty of 10 years and 2 years on electronic components.

INCLUDED

- Mirror (6x700x810mm);
- Concealed siphon;
- Wireless remote control;
- 2x G ½" water connections;
- 2x flexible hoses;
- Wall-fixing material and washbasin fixing material.

ACCESSORIES



LIFT UP SUPPORT RAILS

- Brushed 304 stainless steel tube Ø 30 mm;
- Synthetic resin flange;
- Vertical locking;
- Maximum weight capacity, 120kg;
- Laboratory tests, 225kg.

CODE	DESCRIPTION
879143	Lift-up support rails (x2)





ELECTRONIC CONVERSION KIT

- Pre-installation of the electric connection is needed;
- Transformer is not supplied.

CODE	DESCRIPTION
077754	Electronic conversion kit OLI74 PLUS

PART NUMBER GUIDE

	Glass Black	Glass White	Glass White and mirror	Glass Black and mirror	Lift-up support rails
EASY MOVE WC 	EASY MOVE WC 048159	EASY MOVE WC 048159	-	-	879143
EASY MOVE WC Glass	GLASS 021408	GLASS 021409	-	-	879143
EASY MOVE WASHBASIN 	-	-	EASY MOVE WASHBASIN 881673	EASY MOVE WASHBASIN 881673	-
EASY MOVE WASHBASIN Glass			GLASS 884480	GLASS 884481	

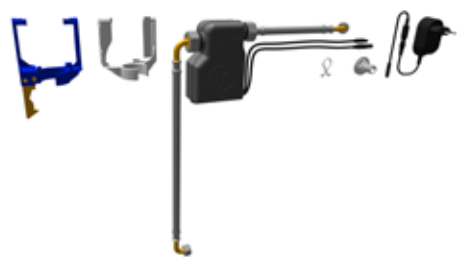

HYDROBOOST CONVERSION KIT

- Uses the energy of water in motion;
- No need to connect to the power grid;
- Suitable for intensive use.



AC CONVERSION KIT

- Pre-installation of the electric connection is needed;
- Transformer is supplied.

CODE DESCRIPTION
878285 Hydroboost conversion kit OLI74 PLUS

CODE DESCRIPTION
878292 AC conversion kit OLI74 PLUS

📦		📦			📦				
WxDxH	Weight	Qt.	Multiple Box Dim	Weight	Qty per Pallet	Pallet Height	Pallet Width	Pallet Length	Weight
1490x280x760	43.09	-	-	-	5	1.65	0.8	1.2	51.38
1420X66X495	-	-	-	-	8	0.85	0.8	1.2	82.17
1400x250x725	34.05	-	-	-	5	1.41	0.8	1.2	208.95
908x110x813	-	-	-	-	5	1.26	0.8	1.2	13.23

IN-WALL INSTALLATION SYSTEMS



OLI has reached a high level of product performance by consistently investing in research and development. The purpose is to guarantee in-wall cisterns as a bathroom solution for solid wall or drywall, as well as applications like thin walls, corner toilets or even toilets under windows.

OLI ensures high quality standards during the tests of its in-wall cisterns for a 400kg load and helps to transform the bathroom into a place of comfort and well-being.

The space gained and simplified bathroom cleaning are also advantages of the in-wall cisterns installation.



IN-WALL INSTALLATION SYSTEMS

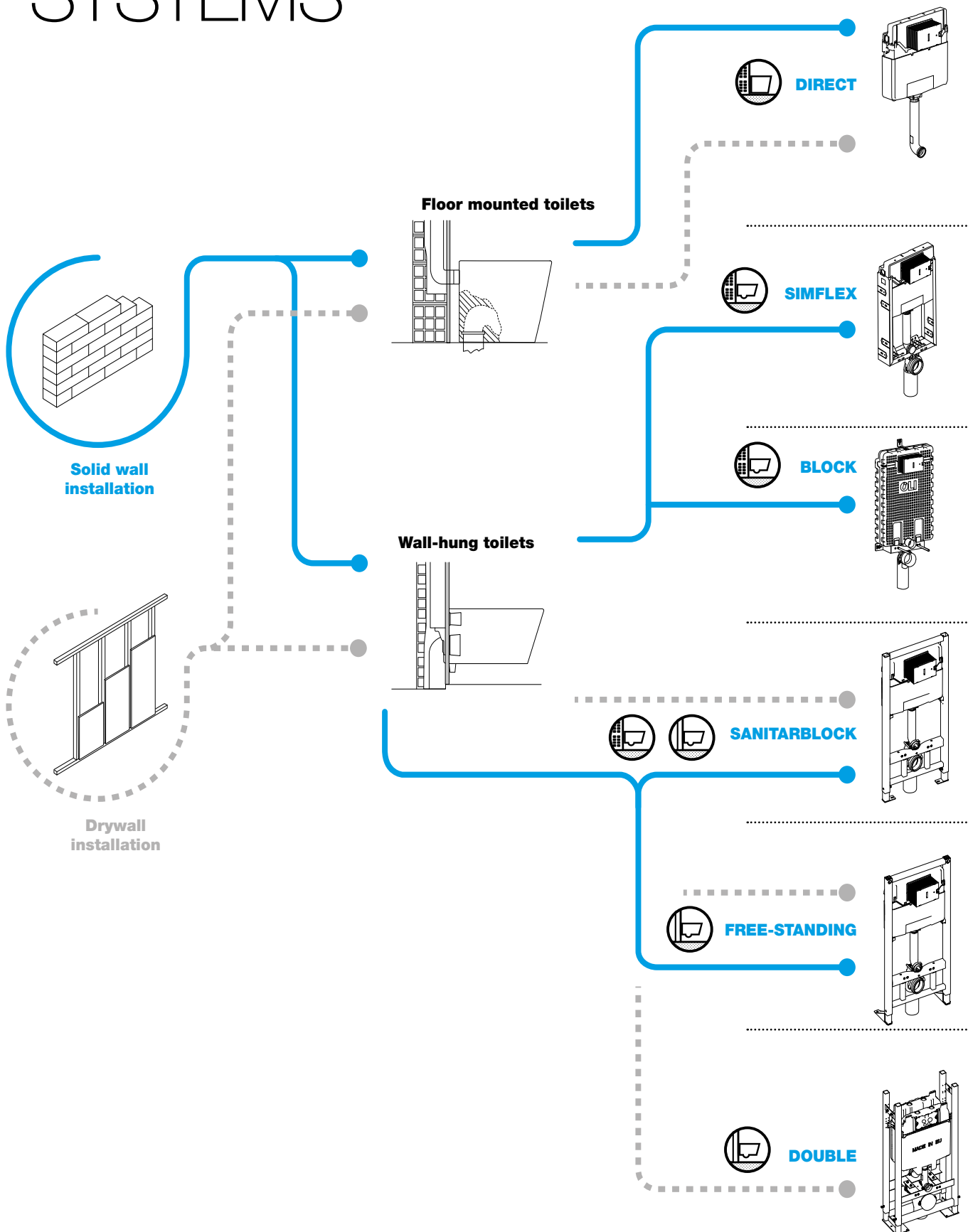

This wall installation system should be selected when installing the cistern in a solid wall that will be brick-lined with a **floor mounted toilet**.



This wall installation system should be selected when installing the cistern in a solid wall that will be brick lined with a **wall-hung toilet**.



This wall installation system should be selected when installing the cistern in a solid wall that will be brick lined with a **wall-hung toilet**. The full EPS coating allows quick and easy installation.



The Sanitarblock installation system is suitable for applications in drywall with load bearing walls. The main advantage of the system is the easiness and speed of safely installing a cistern with a **wall-hung toilet**.



The Sanitarblock free-standing installation system is used in drywall applications with a **wall-hung toilet**. The main advantage of the system is the easiness and speed of safely installing a concealed cistern with a wall hung toilet without the need of any type of wall.

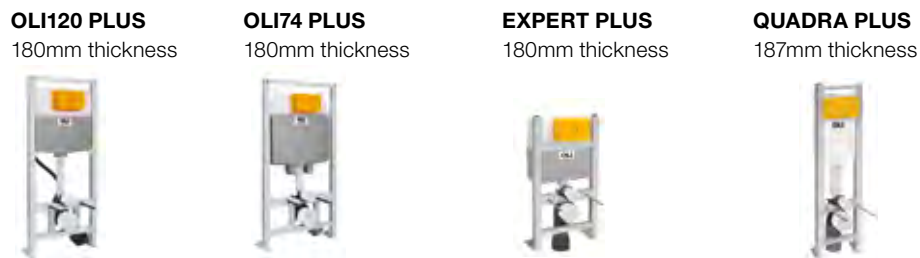

The Sanitarblock free-standing double installation system is ideal for drywall application with a **wall-hung toilet**. This system includes one frame with two cisterns which allows the application of a wall-hung toilet "back-to-back". This makes the Sanitarblock free-standing double ideal for commercial spaces.





All in one range

This flush cistern range stands for innovative applications, like hygienic concepts, renewal air system and shower toilet equipment

880366
OLI 120 PLUS Mechanic Free-standing SHT

216621
BLINK White

OLI120 PLUS

Take quality to a whole new level.

The best OLI technology integrated into a concealed cistern with a thickness that allows easier and faster installation, as well as an effortless maintenance.

Thought out to the last detail and combining the know-how that makes OLI a market reference, with the testimonials from installers and users indicating the strengths they would like brought together in a single product. With this sharing of ideas, OLI120 Plus was born.

Compatibility
Wide range of flush plates



Moon



Glassy



Tribe



Glam



Narrow



Globe



Less is more



Metal



Ria



Slim



Plain



iPlate



River



Blink



Trumpet



Easy Dual



Karisma



Salina



Oceania



SM15



Electra I



Electra II



Electra III



eLine





135980
OLI 120 PLUS Mechanic Sanitarblock SHT

152941
NARROW Matt chrome

OLI120 PLUS



10

10 YEAR WARRANTY

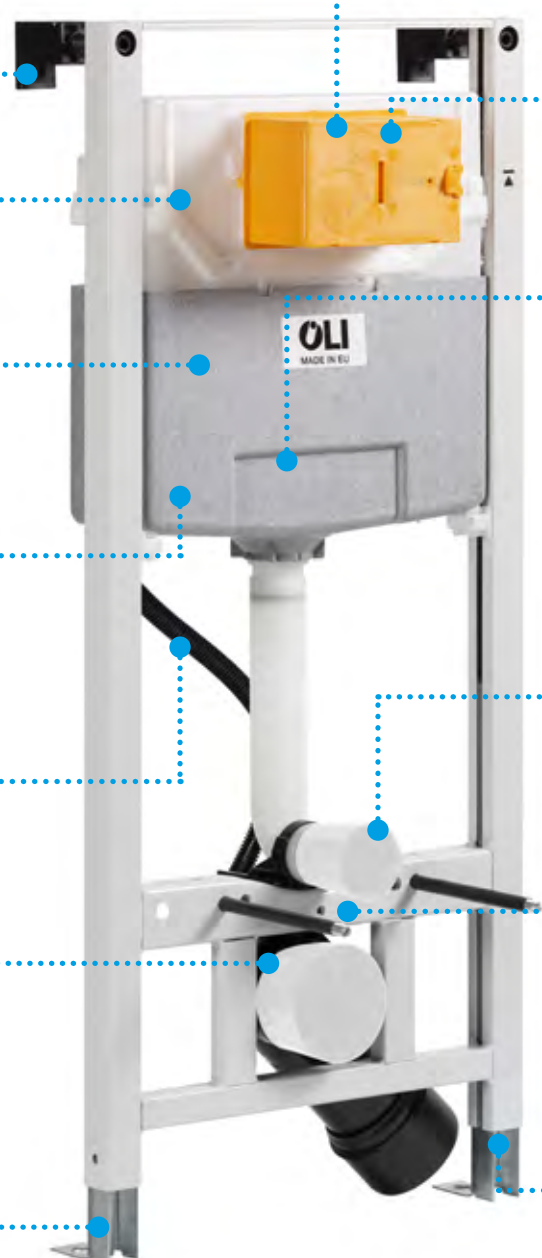

FAST-FIT SYSTEM

POLYPROPYLENE (PP)

Highly resistant cistern inalterable to thermal stress.

SILENT VALVE CLASS 1 CERTIFIED



PLUS

Delayed refill system



SHOWER TOILET

Prepared for shower toilet installation

OUTLET BEND

Fine adjustment of the outlet bend



ONE MAN ASSEMBLY



FRAME TESTED FOR A 400KG LOAD

FLUSH PLATE

Wide range of flush plates and actuations: mechanical, pneumatic, electronic and No-Touch



MAINTENANCE

Transparent protection plate



FLUSH VOLUME

Dual flush: 6/3 litres. Adjustable to 4/2 or 7/3 litres



HAPPY AIR

Fresh solution for air renewal



OLIpure

Cleans and sanitizes the toilet

INSTALLATION SYSTEM



Solid wall-brick lined, and all floor toilets



Solid wall-brick lined, and all wall-hung toilets



Dry wall, and all wall-hung toilets



HEIGHT ADJUSTABLE

in 200mm

EN 14055 CE MARKING



OLI120 PLUS SANITARBLOCK

The Sanitarblock installation system is suitable for applications in drywall with load bearing walls. The main advantage of the system is the ease and speed of safely installing a cistern with a wall-hung toilet.



AUTO-LEVELER

Assembly can be done by only one person, allowing for a fast and precise levelling of the frame.



BLOCKADE

According to the scenario of construction site, the fixation feet have 3 position and a metal blockade to adjust to the intended positions.

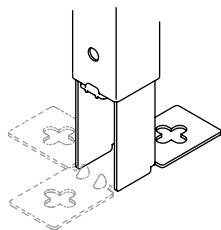

FIXATION FEET

The fixation feet have a cross drill to increase the margin of the holes, facilitating the installation.



OLI120 PLUS DIRECT

This wall installation system should be selected when installing the cistern in a solid wall that will be brick-lined with a floor mounted toilet.



OLI120 PLUS SIMFLEX

This wall installation system should be selected when installing the cistern in a solid wall that will be brick lined with a wall-hung toilet.



OLI120 PLUS SANITARBLOCK FREE-STANDING

The Sanitarblock free-standing installation system is used in drywall applications with a wall-hung toilet. The main advantage of the system is the easiness and speed of safely installing a concealed cistern with a wall hung toilet without the need of any type of wall.





OLI120 PLUS BLOCK

This installation system is for wall-hung toilets and should be used when installing the cistern in a solid wall that will be brick-lined. It is distinguished by an easy and fast installation.



FULL EPS COATING

The Block installation system is also distinguished by the fact that it has a full EPS coating, giving it a strong acoustic resistance.

METAL LINKS

The metal links are fixing supports to rely confidence during the installation of the cistern. Besides ensuring a higher resistance on the fixation, it increases the margin of adjustment according to the wall thickness.



TOILET ADJUSTMENT HEIGHT

Allows the height adjustment of the toilet fixation in three different positions by the maximum of 100mm before the wall is closed.



FAST-FIT

Fast-Fit is a system that provides an easy and strong fixation to the load bearing walls.



**OLI120 PLUS
HEIGHT ADJUSTABLE
FRAME**

OLI120 Plus range as always taken quality to a whole new level and for that, OLI developed this version allowing the height adjust of the toilet fixation positions before closing the wall.



ADJUSTABLE WASTE PIPE CURVE

Polypropylene curve, that connects the toilet to the waste pipe is adjustable in 45° and also adjustable in depth to match the construction site waste pipe.



The OLI120 PLUS HAPPY AIR

is the new solution for renewing
the air in windowless bathrooms.

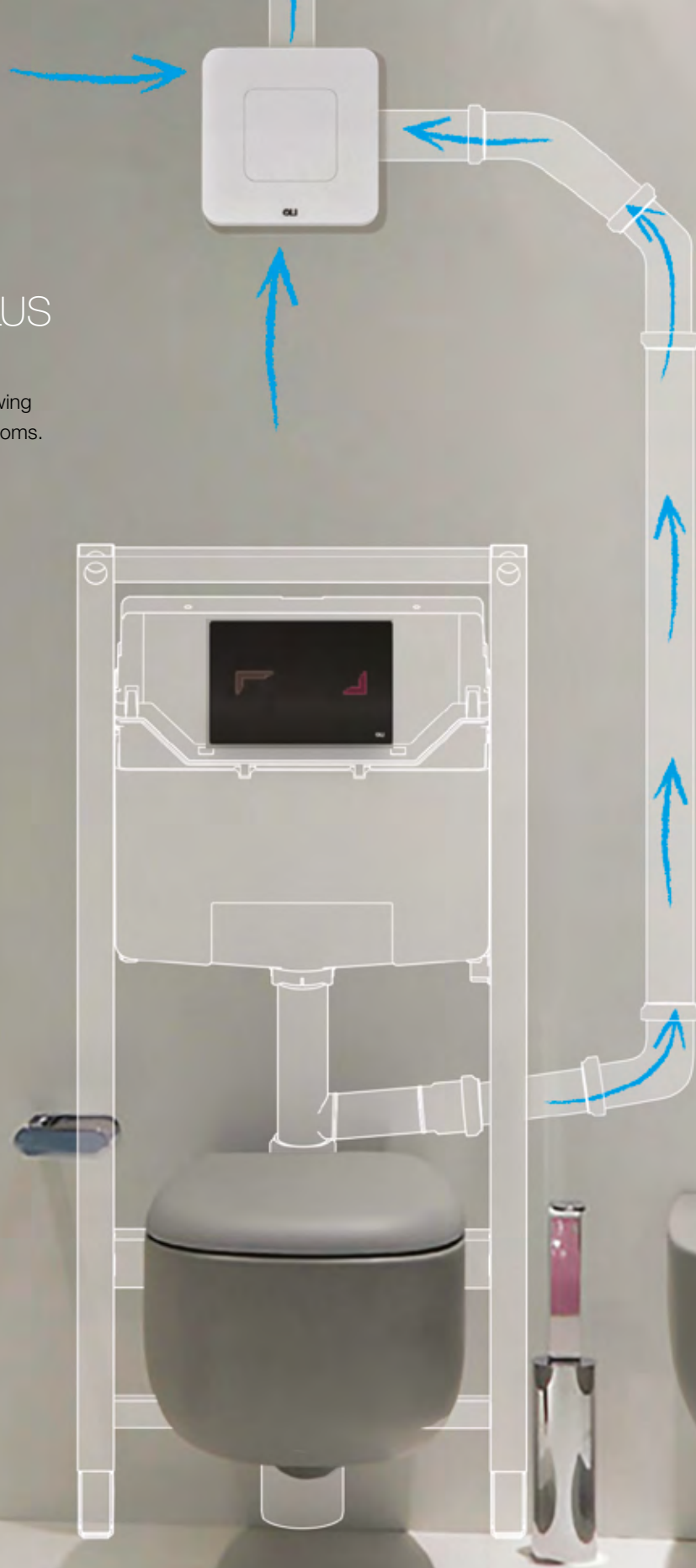

879063
TRIBE Black

883016
OLI120 PLUS Mechanic Sanitarblock Happy Air



OLI120 PLUS HAPPY AIR SANITARBLOCK

HAPPY AIR is a system for air renewal. The high-power and low-noise extractor eliminates odours directly from the toilet and steam in the bathroom via an elegant and discreet plate, installed in the wall or on the ceiling. This system removes odours in 30% from toilet and 70% from the bathroom.

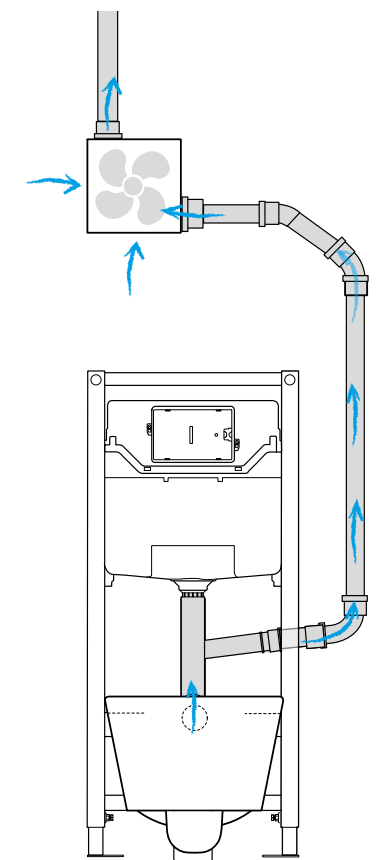

This system is prepared to be connected to a high-power extractor (according one or other version: 80 or 100m³/h) which, thanks to its double vacuum function, allows unpleasant odours to be extracted directly from the toilet through the drain pipe and the condensation to be extracted through an elegant and discreet plate.

MAINTENANCE

The extractor has a melanin filter, which in addition to filtering condensation, has greater durability, since it does not need to be cleaned as often as normal filters and contributes to noise reduction (<38 dB (A)).

KIT HAPPY AIR

KIT HAPPY AIR PLUS

To adjust an OLI120 Plus in-wall cistern, use the Kit Happy Air or Happy Air Plus. This kits include the extractor and the Happy Air flush curve pipe.



HAPPY AIR PLUS

In addition, the version Happy Air Plus has a sensor that allows to adjust the level of humidity at which the fan will initiate, a LED light that helps in case of insufficient light in the bathroom and a timer to adjust the operating time after the user switches the switch off (2-20 minutes).



HAPPY AIR

Happy Air is a version prepared to be connected to a high-power extractor (80m³/h).



HAPPY AIR FLUSH CURVE PIPE

The flush curve pipe adjustable in depth is the means that allows to extract the bad smells from the toilet.



Worried about the
traditional toilet
cleaner that
accumulate germs
in the toilet?

OLIpure is the solution!

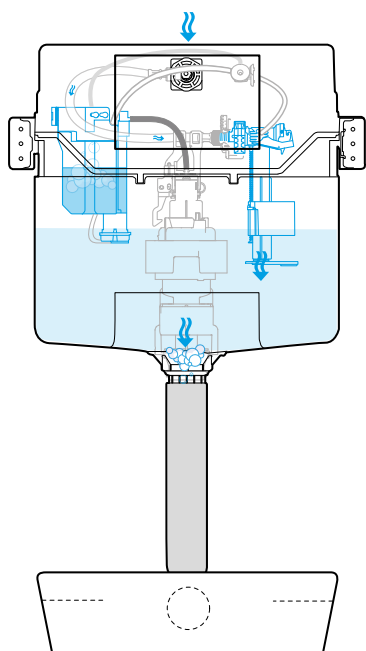

OLI120 PLUS OLIPURE

OLIpure is a self-contained system, placed inside the cistern, where the cleaning liquid is stored. On each flush the disinfectant is dispensed into the toilet, in a control dosage (2ml).

This reduces the risk of the disinfectant damaging components in the cistern. It is compatible with existing WC liquid disinfectants on the market and has a storage capacity of 450ml. OLIpure is in OLI120 Plus range and it allows also add to an existing OLI cistern with the OLIpure kit.



The flush plate range Narrow and Glam of mechanic actuation, are compatible with this sanitizing system. Both hold the opening and closing click system.



Ambiwave is the sanitizing liquid included in OLIpure Kit and on the flush plate range Narrow and Glam, however, it is possible to acquire this separately. See page 62

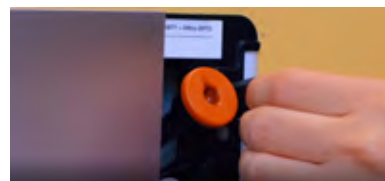

Just fill the tank with Ambiwave liquid or another toilet liquid on the market*, to keep the toilet clean and with a fresh atmosphere in the bathroom.

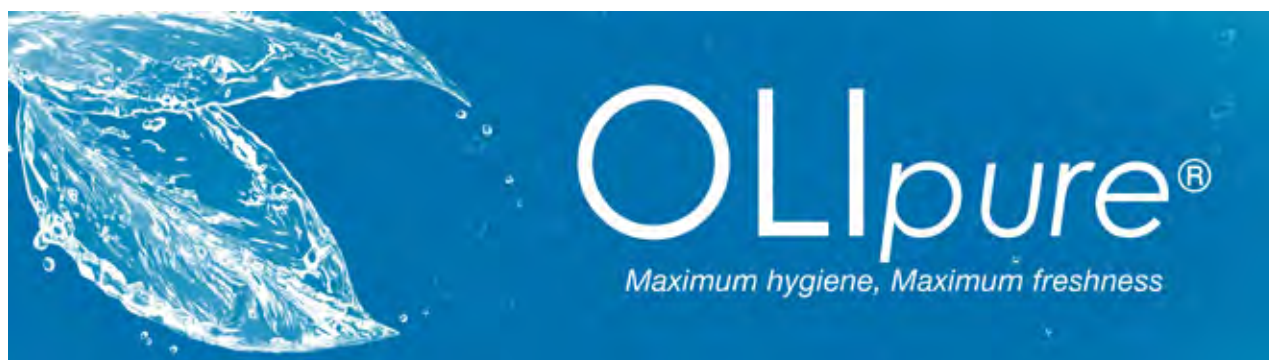

*The use of chlorine-free liquid detergents with a viscosity between 150 and 300 cp (at 20 ° C) is recommended.



OLI120 PLUS SHOWER TOILET (SHT)

OLI 120 Plus range is available with Shower Toilet (SHT) solution that allows the connection between the shower toilet and the in-wall cistern.



FAST-FIT

Fast-Fit is a system that provides an easy and strong fixation to the load bearing walls.



ONE MAN ASSEMBLY

Assembly can be done by only one person, allowing for a fast and precise levelling of the frame.



RETROFIT

OLI120 Plus Shower Toilet incorporated solution allows the installation of a smart toilet seat after the installation of the cistern. This system has the function of being use as a water source for the toilet seat.



SHOWER TOILET AND HAND-HELD SHOWER

The OLI120 Plus in-wall cistern includes a pre-installation for shower toilet and hand-held shower toilets. The shower toilet or hand-held shower toilet can be installed when installing the in-wall cistern or at a later date.



OLI120PLUS SANITARBLOCK FREE-STANDING DOUBLE

Thinking on the multiple possibilities in the bathroom, OLI120 Plus Double Frame comes, with its versatility, to offer a double advantage - toilet/ urinal or toilet/ washbasin. All in one frame, by adding the kit that best fits your need.



Front view

Back view

INSTALL MORE BATHROOMS
IN THE SAME SPACE.

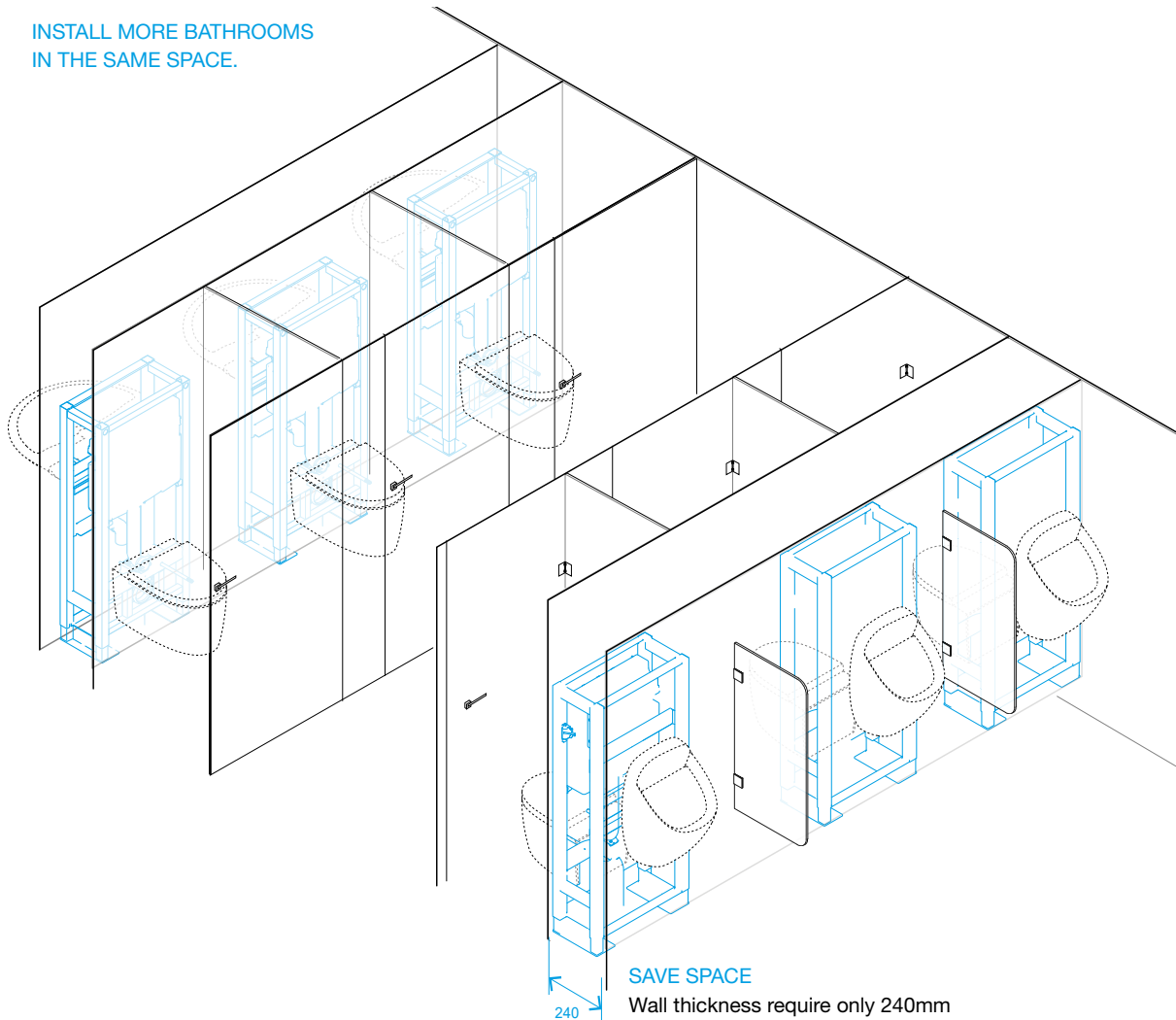

Independently of the bathroom, this product allows to place in one side a toilet and on the other side, a urinal or a washbasin, according to the acquisition of the kits and by sharing the same waste pipe connection, thanks to the evacuation pipe in Y shape. It is prepared to be fix to the floor suitable for plasterboard wall in technical frame.

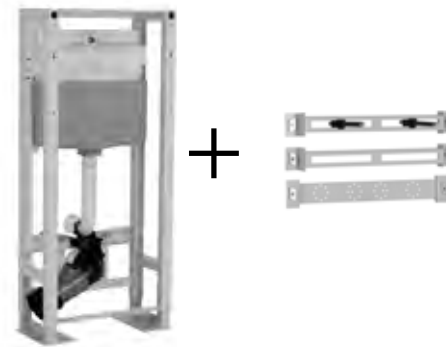
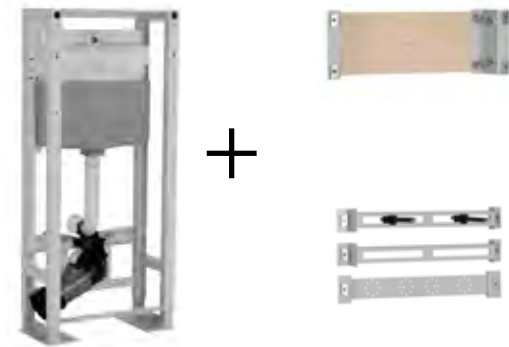

TOILET VS WAHSBASIN WITH WALL MOUNTED FAUCET

This is a solution to have in a frame: one toilet in one side of the wall and a washbasin on the other side. This frame is compatible with all wall hung washbasins and with the acquisition of a kit, adaptable to wall taps. See page 63.

TOILET VS WASHBASIN

This is a solution to have in a frame: one toilet in one side of the wall and a washbasin on the other side. This frame is compatible with all wall hung washbasins and adaptable to wall taps with the acquisition on a kit. See page 63

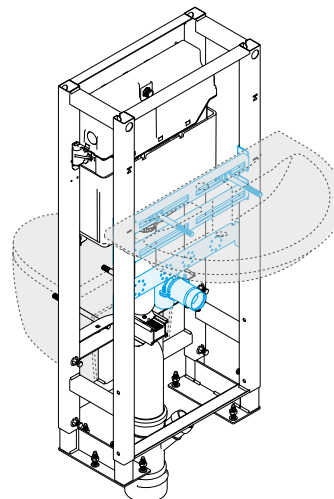
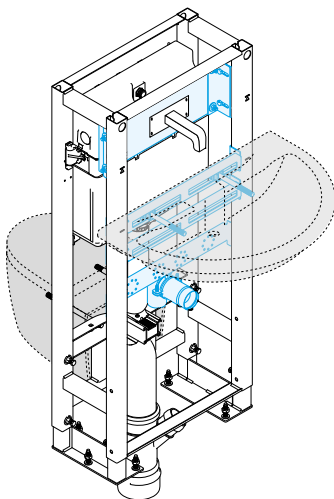



Public Spaces



Public Spaces

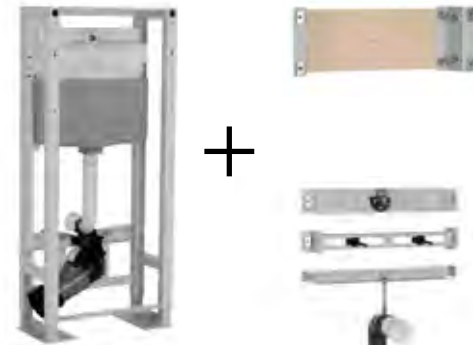
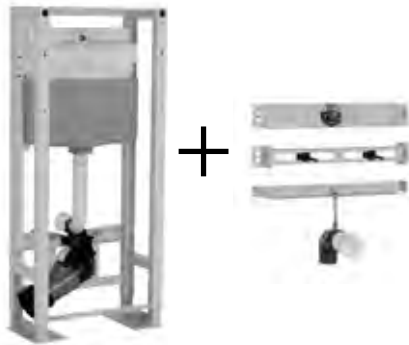

TOILET VS URINAL WITH FLUXOMETER

An optimal solution to have in a frame: one toilet in one side of the wall and a urinal on the other side. The optimization of the bathroom space in a commercial center, a airport or a hospital is guaranteed with the installation of this product. The frame is compatible with all wall hung urinals, and adaptable to fluxometers with the acquisition of a kit. See page 63

TOILET VS URINAL WITH FLUSH PLATE

An optimal solution to have in a frame: one toilet in one side of the wall and a urinal on the other side. The optimization of the bathroom space in a commercial center, a airport or a hospital is guaranteed with the installation of this product. The frame is compatible with all wall hung urinals, and adaptable to flush plates with the acquisition of a kit. See page 63

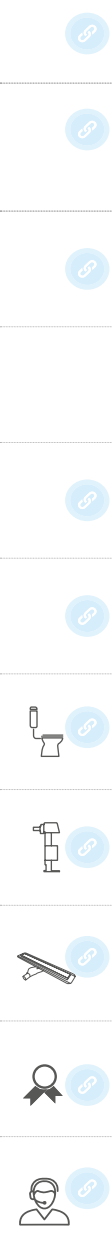
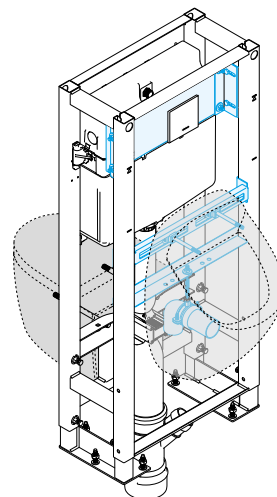
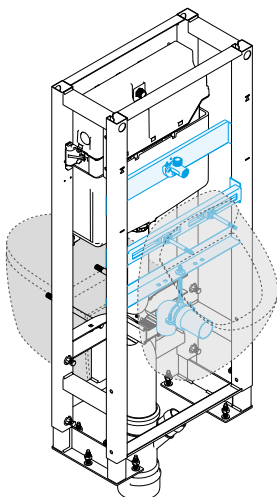

TECHNICAL INFORMATION

OLI120 PLUS

Direct

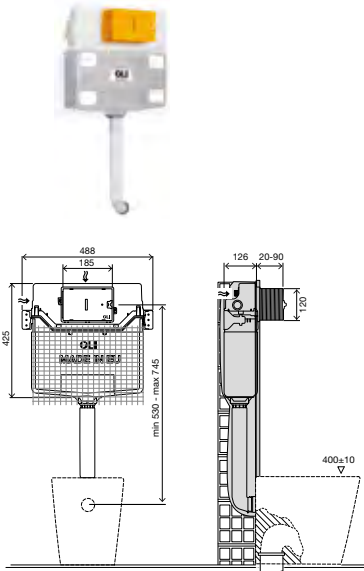

OLI120 PLUS

Simflex

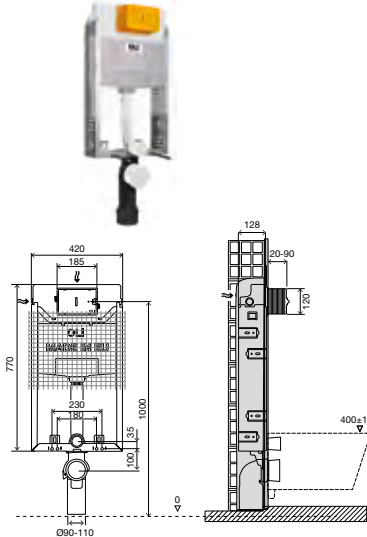

OLI120 PLUS

Block

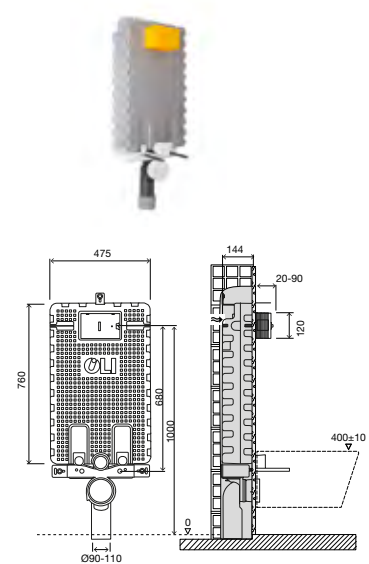

GENERAL FEATURES FOR ALL VERSIONS

- Dual flush 6/3 litre in-wall cistern (adjustable to 4/2 or 7/3 litres);
- Mechanical, Pneumatic, Electronic,
- Hydroboost and AC versions available;
- Polypropylene (PP) cistern highly resistant and inalterable to thermal stress;
- Upon request some versions compliant with: NF/KIWA/BELGAQUA certifications;
- EN 14055 CE Marking;
- Compatible with all floor mounted toilets;
- Solid wall installation;
- 126mm thick.

INCLUDED IN ALL VERSIONS

- Wall fixing kit;
- G 1/2" stop valve;
- Inlet and outlet toilet connection;
- Toilet fixing material (when applicable);
- Outlet bend and Ø90/110 adaptor (when applicable).

SPECIFIC FEATURES

- Compatible with all wall-hung toilets;
- Solid wall installation;
- 128mm thick.

SPECIFIC FEATURES

- Compatible with all wall-hung toilets;
- Solid wall installation;
- Robust EPS block that completely encloses the cistern and allows for faster installation;
- 144mm thick.



OLI120 PLUS

Sanitarblock

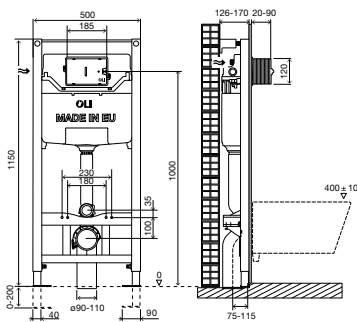

SPECIFIC FEATURES

- Wall hung toilets up to 660mm long;
- Solid wall or drywall installation;
- Frame tested for a 400kg load;
- Depth adjustable outlet bend;
- Easy and quick installation with fast fit system;
- Height adjustable from 0 to 200mm;
- One man assembly;
- 126mm thick.



OLI120 PLUS SHT

Sanitarblock

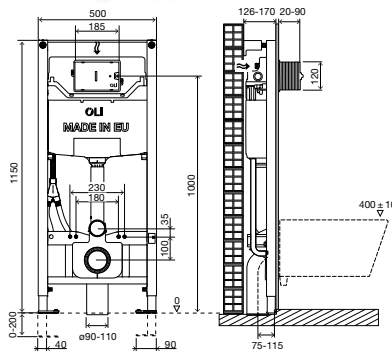

SPECIFIC FEATURES

- Wall hung toilets up to 660mm long;
- Solid wall or drywall installation;
- Frame tested for a 400kg load;
- Depth adjustable outlet bend;
- Easy and quick installation with fast fit system;
- Height adjustable from 0 to 200mm;
- One man assembly;
- 126mm thick.

OLI120 PLUS

Height Adjustable Sanitarblock

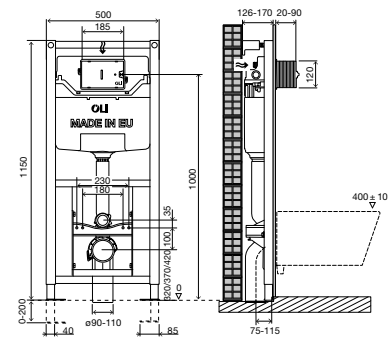

SPECIFIC FEATURES

- Compatible with all wall-hung toilets;
- Solid wall or drywall installation;
- Frame tested for a 400kg load;
- Depth adjustable outlet bend;
- Allows the height adjustment of the toilet fixation in three different positions before closed the wall, between 320 to 420mm;
- Easy and quick installation with fast fit system;
- Height adjustable from 0 to 200mm;
- 126mm thick.



OLI120 PLUS

Free-standing

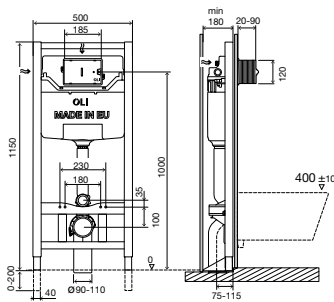

OLI120 PLUS SHT

Free-standing

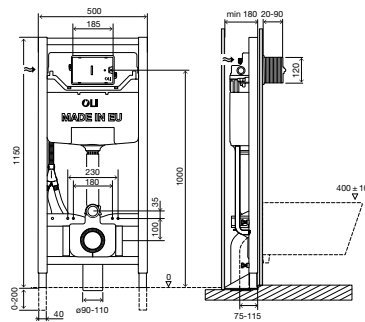

OLI120 DOUBLE FRAME

WC | URINAL/WASHBASIN

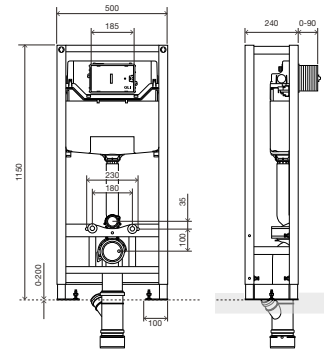

GENERAL FEATURES FOR ALL VERSIONS

- Compatible with all wall-hung toilets;
- Drywall installation;
- Depth adjustable outlet bend;
- Frame tested for a 400kg load;
- Height adjustable from 0 to 200mm;
- 180mm thick.

INCLUDED IN ALL VERSIONS

- Toilet fixing material;
- Frame fixing material (floor);
- Inlet and outlet toilet connection;
- Outlet bend and Ø90/110 adaptor;
- G ½" stop valve.

SPECIFIC FEATURES

- Prepared for shower toilet installation, kit sold separately;
- Compatible with all wall-hung toilets;
- Drywall installation;
- Depth adjustable outlet bend;
- Frame tested for a 400kg load;
- Height adjustable from 0 to 200mm;
- 180mm thick.

SPECIFIC FEATURES

- Frame with cistern and urinal or washbasin installed back-to-back;
- Freestanding double frame;
- Wall hung toilets up to 660mm long;
- Drywall installation;
- Frame tested for a 400kg load;
- Height adjustable from 0 to 200mm;
- 240mm thick.



OLI120 PLUS HAPPY AIR

Sanitarblock

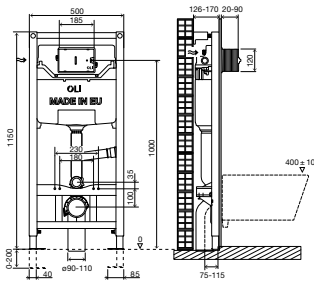

HAPPY AIR

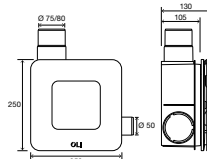

HAPPY AIR PLUS

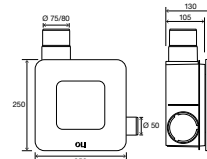

SPECIFIC

- Wall hung toilets up to 660mm long;
- Flush pipe for happy air system;
- Solid wall or drywall installation;
- Frame tested for a 400kg load;
- Depth adjustable outlet bend;
- Easy and quick installation with fast fit system;
- Height adjustable from 0 to 200mm;
- One man assembly;
- 126mm thick.

GENERAL FEATURES

- High extraction capacity (80m³/h)**
- Removes 30% of odours
- Removes 70% of condensation
- Melanine filter – noise reduction;
- Turns off as soon as the client turns off the switch;
- 220V/50Hz;
- Capacity 65m³/h- 22W 31dB;
- Capacity 80m³/h- 29W 35dB.

GENERAL FEATURES

- High extraction capacity (100m³/h)**
- Removes 30% of odours
- Removes 70% of condensation
- Melanine filter – noise reduction;
- 960 Lumen LED that can be turn on independently of the extractor;
- Humidity sensor that can be set to automatically turn on;
- Possible to adjust the operating time after the user switches the switch off (2min-20min);
- Capacity 100m³/h- 12W 34dB;
- Capacity 80m³/h- 20W 38dB.

ACCESSORIES



PNEUMATIC CONVERSION KIT

- 2 pneumatic pipes with 350mm;
- Outlet valve pneumatic anchors;
- Pneumatic bellows.

CODE	DESCRIPTION
154084	Pneumatic conversion Kit OLI120 PLUS



ELECTRONIC CONVERSION KIT

- Pre-installation of the electric connection is needed;
- Transformer is not supplied.

CODE	DESCRIPTION
154085	Electronic conversion Kit OLI120 PLUS



ACCOUSTIC INSULATION TOILET AND BIDET

- Acoustic insulation in expanded polyethylene;
- Avoids direct contact between the sanitaryware and the tile.

CODE	DESCRIPTION
620071	Acoustic insulation toilet



HYDROBOOST CONVERSION KIT

- Uses the energy of water in motion;
- No need to connect to the power grid;
- Suitable for intensive use.

CODE	DESCRIPTION
878294	Hydroboost conversion Kit OLI120 PLUS



AC CONVERSION KIT

- Pre-installation of the electric connection is needed;
- Transformer is supplied.

CODE	DESCRIPTION
878293	AC conversion kit OLI 120 PLUS



ACCOUSTIC INSULATION WASHBASIN

- Acoustic insulation in expanded polyethylene;
- Avoids direct contact between the washbasin and tile.

CODE	DESCRIPTION
620072	Acoustic insulation washbasin



OLIPIRE KIT

- Compatible with Glam and Narrow flush plates.

CODE	DESCRIPTION
882129	OLIpure kit



AMBIWAVE

- Liquid disinfectant for toilet;
- 450ml dosage;
- 12 units per pack.

CODE	DESCRIPTION
879955	Ambiwave-OLIpure



ECCENTRIC SET CONNECTION 25MM

- Accessory sets to enable the correction of incorrect applications.
- Toilet connection Ø90;
- Connection WC pipe Ø45x180.

CODE	DESCRIPTION
885108	Eccentric set connection 25mm



WASHBASIN KIT FOR DOUBLE FRAME

- Easy and quick installation;
- Washbasin fixing material;
- Compatible with wall-hung washbasins; Outlet bend Ø40 - 32/50mm - 40mm.

CODE	DESCRIPTION
882613	Washbasin Kit



URINAL KIT FOR DOUBLE FRAME

- Easy and quick installation;
- Urinal fixing material;
- Outlet bend Ø40 - 32/50mm - 40mm;
- G 1/2 fitting for water connection.

CODE	DESCRIPTION
882612	Urinal Kit



HAPPY AIR KIT PLUS

- Transform any OLI120 PLUS concealed cisterns with this KIT;
- 1 Outlet pipe connection;
- 1 Happy Air fan Plus.

CODE	DESCRIPTION
884341	Happy Air Plus kit OLI120 Plus



WALL TAP/CONCEALED FLUSH VALVE

- Compatible with all taps and urinal;
- Concealed flush;
- Adjustable mounting wood panel;
- Fixing material.

CODE	DESCRIPTION
881858	Wall tap or concealed urinal flush valve



CONCEALED SIPHON

- Compatible for double frame with washbasin kit;
- Outlet bend Ø32-32mm;
- Wall plate can be customized.

CODE	DESCRIPTION
883081	Washbasin Siphon



HAPPY AIR KIT

- Transform any OLI120 PLUS concealed cisterns with this KIT;
- 1 Outlet pipe connection;
- 1 Happy Air fan.

CODE	DESCRIPTION
884343	Happy Air kit OLI120 Plus



LONGER SLEEVES FOR WALL HUNG TOILETS

- Outlet pipe Ø90xØ125x300;
- Rubber seal for outlet pipe Ø125;
- Connection WC pipe Ø45x280;
- Rubber seal for WC pipe Ø45;
- M12x300 rods for wall-hung toilets fixation;
- Counter plate fixation screws;
- Fixing toilet accessories.

CODE	DESCRIPTION
011229	Longer sleeves for wall-hung WC toilet



SHOWER TOILET CONNECTION KIT

- Allows the connection between the cistern and the shower toilet;
- 1 flexible hose 1200mm;
- 2 flexible hose 3/8x3/8 160mm;
- 1 stop valve 1/2x1/2;
- 1 brass connection (T).

CODE	DESCRIPTION
191887	Shower toilet connection kit



BYPASS CONNECTOR

- Connector between the outlet pipe and the outlet bend;
- The flushing can be tested before toilet installed.

CODE	DESCRIPTION
885233	Bypass connector

PART NUMBER GUIDE

	 Mechanic	 OLipure	 Pneumatic	 Electronic	 Hydroboost	 AC	 HAPPY AIR
OLI120 PLUS Direct 	Azor Plus 099941 Nano Plus 885049	880777	Azor Plus 153964	154075	878843	878619	-
OLI120 PLUS Simflex 	Azor Plus 099946 Nano Plus 885051	880778	Azor Plus 154078 Nano Plus 885054	154079	878844	878620	-
OLI120 PLUS Block 	Azor Plus 151339 Nano Plus 885050	880779	Azor Plus 154076 Nano Plus 885053	154077	878845	878623	-
OLI120 PLUS Sanitarblock 	Azor Plus 99949 Nano Plus 885052	880780	Azor Plus 177306 Nano Plus 885055	177305	878846	878621	883016 Fan 880376 Fan Plus 880377
OLI120 PLUS Free-standing 	099952	880781	99951	99943	878847	878622	-
OLI120 PLUS Height Adjustable Sanitarblock 	154083	-	-	-	-	-	-
OLI120 PLUS Sanitarblock SHT 	135980	-	-	-	-	-	-
OLI120 PLUS Free-standing SHT 	880366	-	-	-	-	-	-
OLI120 PLUS Double Frame 	882618	-	-	-	-	-	-

WxDxH	Weight	Qt.	Multiple Box Dim	Weight	Qty per Pallet	Pallet Height	Pallet Width	Pallet Length	Weight
670x150x460	3.68	-	-	-	45	2.46	0.82	1.28	368.55
915x450x160	8.43	-	-	-	35	2.41	1	1.2	310.15
486x161x1070	7.22	-	-	-	26	2.21	1	1.2	200.05
1180x140x530	13.08	-	-	-	20	2.35	0.84	1.2	287.69
1180x140x530	15.91	-	-	-	20	2.35	0.8	1.2	343.76
1180x140x530	16.12	-	-	-	20	2.48	0.8	1.2	318.14
1180x140x530	13.84	-	-	-	20	2.35	0.8	1.2	302.46
1180x140x530	16.35	-	-	-	20	2.35	0.8	1.2	352.59
1176x256x545	26.6	1	-	-	6	1250	800	1200	159.6

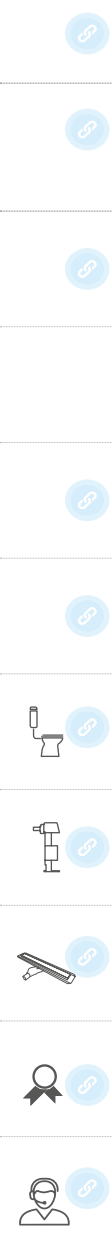

OLI74 PLUS is the
most versatile and
water efficient
range

Suitable for any type of
solid wall, drywall and floor
mounted toilets or wall-hung
toilets.

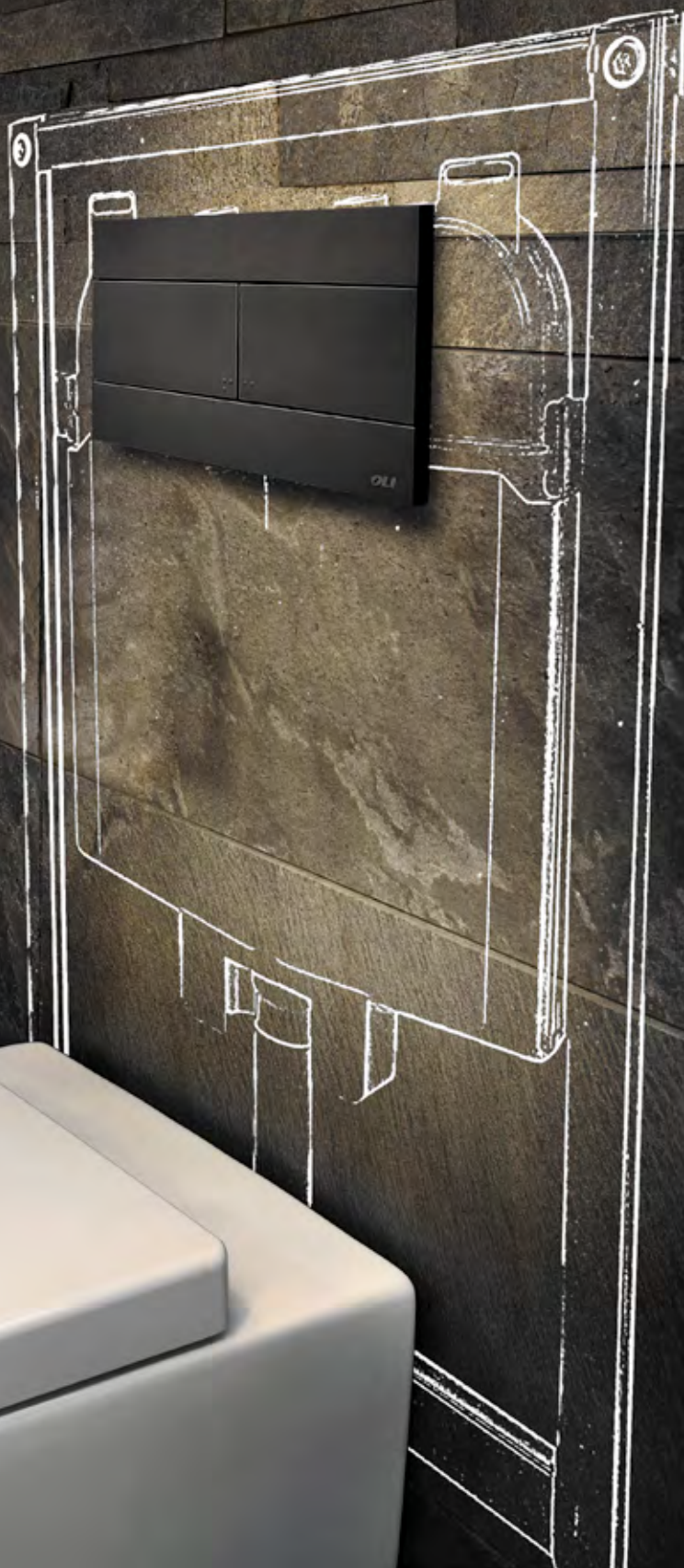

601821
OLI74 PLUS Mechanic Sanitarblock

659055
SLIM Black soft-touch

OLI74 PLUS

OLI BELIEVES IN A WATER-EFFICIENT BATHROOM.

OLI's Research and Development Centre worked on the conception of OLI74 Plus range as a solution that increases water efficiency in the bathroom. This range matches with all OLI flush plates developed using the latest technology and always respecting environmental concerns. These range of in-wall cisterns covers every single need for public or private bathrooms.

Compatibility Wide range of flush plates

Moon	Glam	Metal	Ria Stop	Plain	Blink	Salina	Electra I	
Glassy	Narrow	Ino-x	Ria	iPlate	Trumpet	Oceania	Electra II	
Tribe	Globe	Slim	Oceania	River	Easy Dual	SM15	Electra III	
	Less is more				Karisma		eLine	

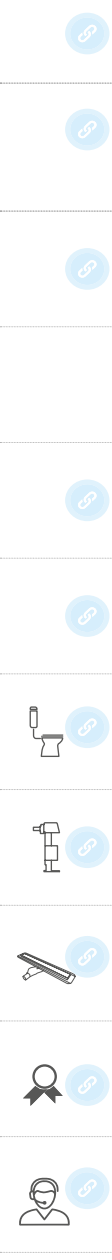



878700
GLASSY Gold

187650
OLI74 PLUS Electronic S90 Sanitarblock

OLI74 PLUS

10

10 YEAR WARRANTY



MAINTENANCE

Offers first set of spare parts (flushing mechanism rubber and seal)



PLUS

Delayed refill system

SILENT VALVE CLASS 1 CERTIFIED



2 INLET VALVES

Allows you to connect the cistern to a second water source.



90mm

Minimum thickness

OUTLET BEND
Fine adjustment of the outlet bend



HEIGHT ADJUSTABLE
in 150mm



FLUSH PLATE

Wide range of flush plates and actuations: mechanical, pneumatic, electronic and no-touch



FLUSH VOLUME

Dual flush: 6/3 adjustable to 4.5L/3L



HAPPY AIR

Fresh solution for air renewal



OLIpure

Cleans and sanitizes the toilet





OLI74 PLUS DIRECT

This wall installation system should be selected when installing the cistern in a solid wall that will be brick-lined with a floor mounted toilet.



OLI74 PLUS SIMFLEX

This wall installation system should be selected when installing the cistern in a solid wall that will be brick lined with a wall-hung toilet.



OLI74 PLUS FREE-STANDING

The Sanitarblock Free-Standing installation system is used in drywall applications with a wall-hung toilet. The main advantage of the system is the easiness and speed of safely installing a concealed cistern with a wall-hung toilet without the need of any type of wall.



Projects



AZORIS ROYAL GARDEN HOTEL, AZORES, PORTUGAL

Located in S. Miguel Island, the 4-star hotel features an outdoor pool with a terrace lounge and offers air-conditioned guestrooms with balconies. Royal Garden rooms have modern furnishings and are decorated in neutral colours. Their private bathrooms are equipped with OLI74 PLUS S90 Sanitarblock and Blink flush plate.



OLI74 PLUS S90 SANITARBLOCK

In-wall cistern for thin walls.

OLI presents one of the best solutions for bathrooms with solid wall or drywall and installation of wall-hung toilets. The S90 means that the cistern has a depth of 90mm, which makes ideal for thin walls.



METAL LINKS

The metal links are fixing supports to rely confidence during the installation of the cistern. Besides ensuring a higher resistance on the fixation, it increase the margin of adjustment according to the wall thickness.



FIXATION FEET

The fixation feet are adjustable in 150mm, allowing an easy installation of the cistern. For a regulation up to 300mm, OLI as a kit to help. See page 84.



ADJUSTABLE WASTE PIPE CURVE

Polypropylene curve, that connects the toilet to the waste pipe is adjustable in 45° and also adjustable in depth to match the construction site waste pipe.





600859
OLI74 PLUS Mechanic Free-standing double

79206
ELECTRA III Polished chrome zamac

OLI74PLUS SANITARBLOCK FREE-STANDING DOUBLE

This in-wall cistern is ideal for drywall application with a wall-hung toilet. This includes one frame with two cisterns which allows the application of a wall-hung toilet back-to-back. This makes the Sanitarblock free-standing double ideal for commercial spaces.

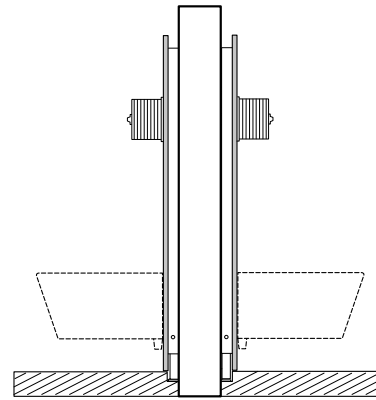

Projects



MIAL ALMICASA NURSERY HOME, GALAPAGAR, SPAIN

Space dedicated to the elderly welfare, this nursery home as the purpose of ensuring the satisfaction of their individual needs. Their bathrooms are equip with OLI74 Plus Sanitarblock Free-Standing Double.



WASTE PIPE CURVE IN PEHD

Equip with this evacuation pipe in "Y" shape, it allows the different sanitary ware to connect to the same waste pipe.

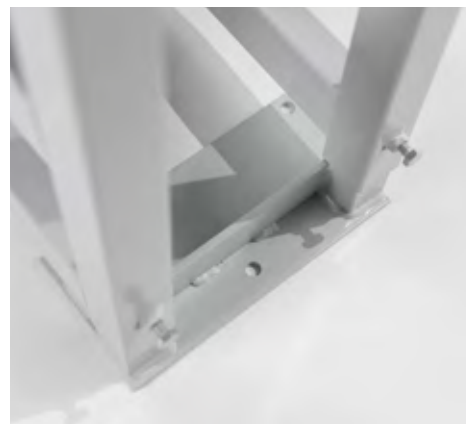

CISTERN FIXATION

The frame is prepared to be fixated to the floor, suitable for plasterboard wall or technical frames.



Worried about the traditional
toilet cleaner that accumulate
germs in the toilet?
OLIpure is the solution!



SAFE AND INNOVATIVE SYSTEM

Doesn't contaminate the water or any
component inside the cistern - closed system;



USER FRIENDLY

Easy and quick refill.



CONTROLLED DOSING

Releases only 2ml per flush – long lasting.



AMBIWAVE*

450ml dosage.

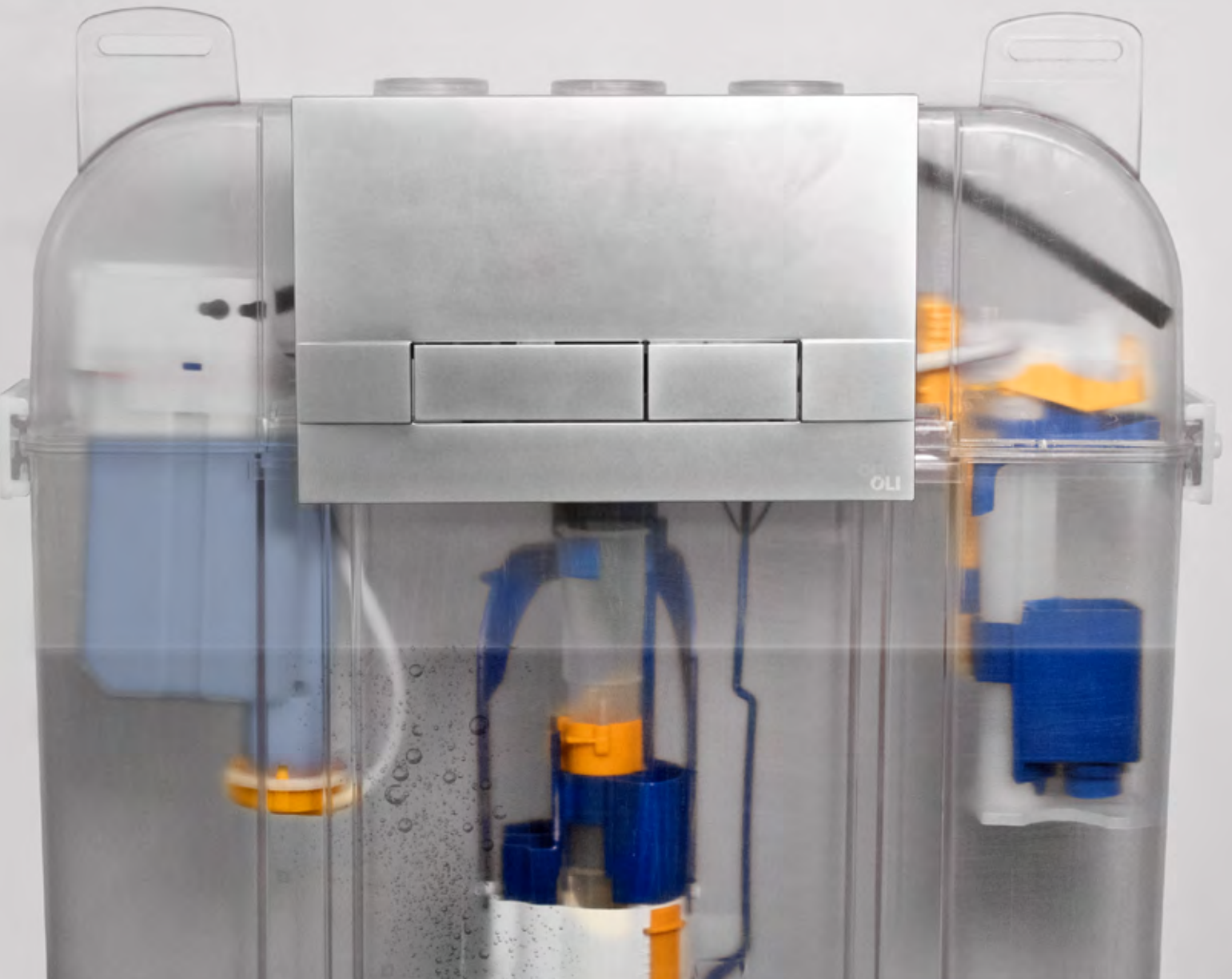



OLIpure®



OLI74 PLUS OLIPURE

OLIpure is a self-contained system, placed inside the cistern, where the cleaning liquid is stored. On each flush the disinfectant is dispensed into the toilet, in a control dosage.

This reduces the risk of the disinfectant damaging components in the cistern. It is compatible with existing WC liquid disinfectants on the market and has a storage capacity of 450ml.

OLIpure is in OLI74 Plus range and it allows also to upgrade an existing OLI cistern already install.

PURO TOWER AND PURO HOMES RESIDENCES, AVEIRO, PORTUGAL

One of the most recent projects in the famous Portuguese Venice, equipped their bathrooms with OLI products. The residencies PURO TOWER and PURO HOMES in Aveiro City are equip with the OLIpure version of OLI74 Plus range.



Narrow and Glam flush plate range of mechanic actuation, are compatible with this hygienic system. Both detain the opening and closing click system.



Ambiwave is our disinfectant liquid, included in OLIpure kit and in our flush plate range Narrow and Globe, however, it is possible to purchase the disinfectant liquid separately. See page 83.



Just fill the tank with Ambiwave liquid or another toilet liquid on the market*, to keep the toilet clean and with a fresh atmosphere in the bathroom.



*The use of chlorine-free liquid detergents with a viscosity between 150 and 300 cp (at 20 ° C) is recommended.

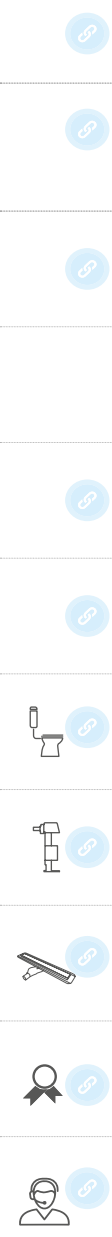

The OLI 74
PLUS HAPPY AIR
is the new solution for
renewing the air in windowless
bathrooms.

880377
HAPPY AIR FAN PLUS

054558
OCEANIA mech stainless steel button - glass White



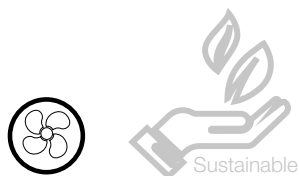

OLI74 PLUS HAPPY AIR SANITARBLOCK

HAPPY AIR is a system for air renewal. The high-power and low-noise extractor eliminates odours directly from the toilet and steam in the bathroom via an elegant and discreet plate, installed in the wall or on the ceiling. This system removes odours in 30% from toilet and 70% from the bathroom.

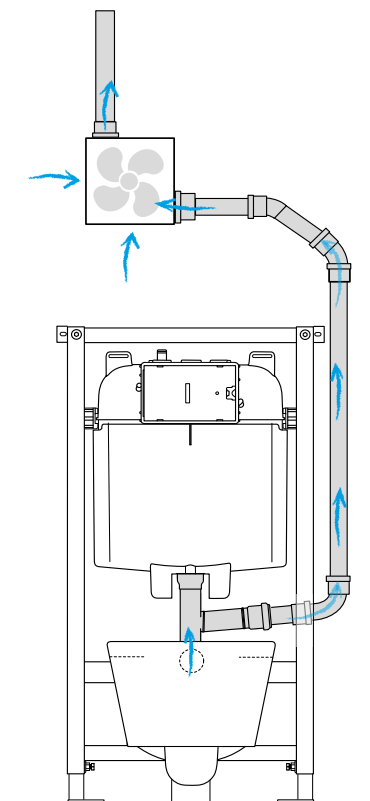

This system is prepared to be connected to a high-power extractor (according one or other version: 80 or 100m³/h) which, thanks to its double vacuum function, allows unpleasant odours to be extracted directly from the toilet through the drain pipe and the condensation to be extracted through an elegant and discreet plate.

MAINTENANCE

The extractor has a melanin filter, which in addition to filtering condensation, has greater durability, since it does not need to be cleaned as often as normal filters and contributes to noise reduction (<38 dB (A)).

KIT HAPPY AIR KIT HAPPY AIR PLUS

To adjust an OLI74 Plus in-wall cistern, use the Kit Happy Air or Happy Air Plus. This kits include the extractor and the Happy Air flush pipe curve.



HAPPY AIR PLUS

In addition, the version Happy Air Plus has a sensor that allows to adjust the level of humidity at which the fan will initiate, a LED light that helps in case of insufficient light in the bathroom and a timer to adjust the operating time after the user switches the switch off (2-20 minutes).



HAPPY AIR

Happy Air is a version prepared to be connected to a high-power extractor (80m³/h).



HAPPY AIR FLUSH PIPE CURVE

The flush pipe curve, adjustable in depth, is the means that allows to extract the bad odors from the toilet.



880791
OLI74 PLUS Mechanic
4/2l Sanitarblock 2 inlet valves

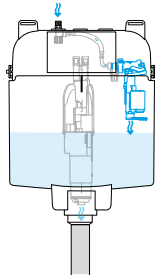

OLI74 PLUS DELAYED REFILL SYSTEM

PLUS system allows a water saving of up to 0.5 liters on average with each flush, resulting in a daily average saving of 9 liters.



OLI74 PLUS 4/2 L

Save water in every flush.
2 liters in full flush and 1 liter in half flush.

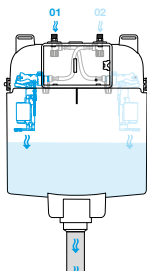

OLI74 PLUS 2 INLET VALVE

1 in-wall cistern, 2 inlet valve (1) (2).

These cisterns are distinguished by having a double entry of water, one for drinking water and the other one for non-drinking water. This allows us, for example, to use rainwater for flushing, as an alternative to drinking water. It provides a more efficient use of water while reducing the water bill.

SAVE 100%

Connected only to second source

SAVE 50%

Connected to the network + second source



SUSTAINABILITY

The use of non-drinking water in sanitary installation systems is a response to reduce water consumption in the bathroom. According to United Nations recent forecasts there will be a water deficit of 40% worldwide in 2030. Therefore, it is urgent to adopt new consumption patterns, especially in the bathroom, since it accounts for 33% of domestic consumption. OLI has developed an innovative solution which is the core to OLI's DNA: OLI74 Plus 2 inlet valves cistern.



BELAS CLUBE DE CAMPO RESIDENCES, LISBON, PORTUGAL

Belas Clube de Campo is the first real estate project to be distinguished by ADENE - Energy Agency, with AQUA+, the new building water performance index.

To ensure better performance and water efficiency, Belas Clube de Campo has implemented several measures, among them we highlight the installation of OLI74 Plus 2 inlet valve. Altogether these features guarantee a very significant reduction in water consumption in the bathroom. The Belas Clube de Campo Project, in Lisbon, has adopted this type of flush cisterns to accomplish the mission of water sustainability in its bathrooms.



TECHNICAL INFORMATION

OLI74 PLUS

Direct

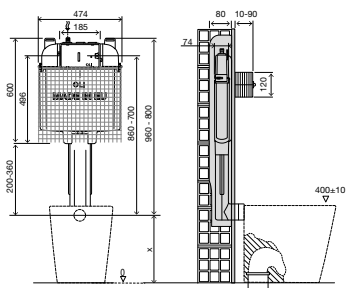

GENERAL FEATURES FOR ALL VERSIONS

- Dual flush 6/3 litre in-wall cistern (adjustable to 4.5/3 litres);
- Mechanical, Pneumatic, Electronic, Hydroboost and AC versions available;
- Polypropylene (PP) cistern highly resistant and inalterable to thermal stress;
- Upon request some versions compliant with: SAI-WATERMARK/UPC/KIWA/SABS;
- EN 14055 CE Marking;
- Compatible with all floor mounted toilets;
- Solid wall installation;
- 80mm thick.

INCLUDED IN ALL VERSIONS

- Wall fixing kit;
- G 1/2" stop valve;
- Inlet and outlet toilet connection;
- Toilet fixing material (when applicable);
- Outlet bend and Ø90/110 adaptor (when applicable).



OLI74 PLUS

Simflex

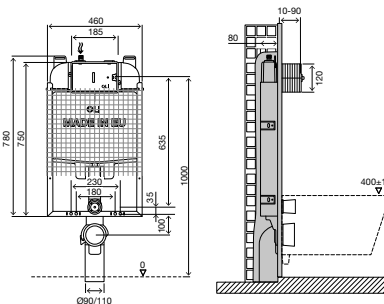

SPECIFIC FEATURES

- Compatible with all wall-hung toilets;
- Solid wall installation;
- 80mm thick.



OLI74 PLUS

S90 Sanitarblock

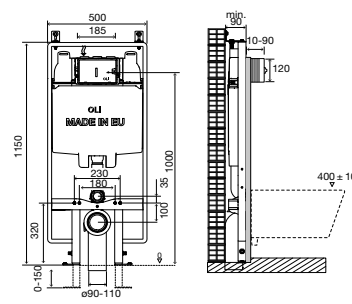

SPECIFIC FEATURES

- Compatible with all wall-hung toilets;
- Solid wall or drywall installation;
- Easy and quick installation;
- Depth adjustable outlet bend;
- Height adjustable from 0 to 150mm;
- Option kit to adjust until 300mm;
- 90mm thick.



OLI74 PLUS

Sanitarblock

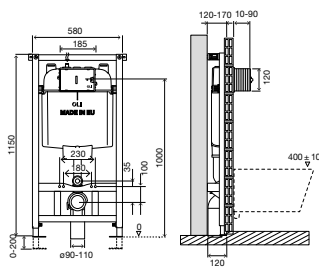

SPECIFIC FEATURES

- Compatible with all wall-hung toilets;
- Solid wall or drywall installation;
- Frame tested for a 400kg load;
- Easy and quick installation with fast fit system;
- Depth adjustable outlet bend;
- Height adjustable from 0 to 200mm;
- 120mm thick.



OLI74 PLUS

Free-standing

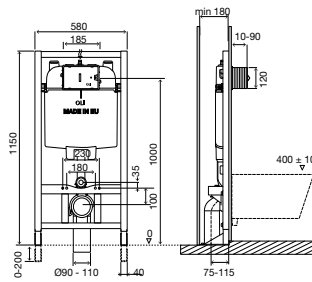

SPECIFIC FEATURES

- Compatible with all wall-hung toilets;
- Drywall installation;
- Depth adjustable outlet bend;
- Frame tested for a 400kg load;
- Height adjustable from 0 to 200mm;
- 180mm thick.



OLI74 PLUS

Free-standing Double

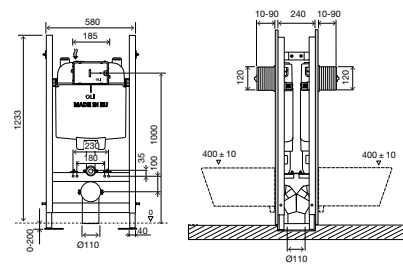

SPECIFIC FEATURES

- Compatible with all wall-hung toilets;
- Drywall installation;
- Frame tested for a 400kg load;
- Height adjustable from 0 to 200mm;
- Frame for back to back wall-hung toilet with two in-wall cisterns;
- 240mm thick.



OLI74 PLUS HAPPY AIR

Sanitarblock

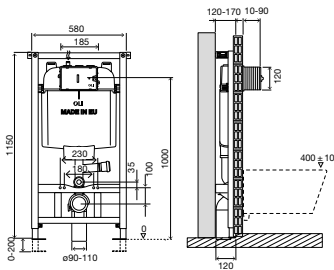

HAPPY AIR

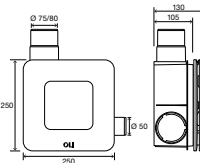

HAPPY AIR PLUS

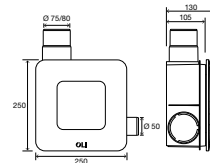

SPECIFIC

- Compatible with all wall-hung toilets;
- Flush pipe for happy air system;
- Solid wall or drywall installation;
- Frame tested for a 400kg load;
- Easy and quick installation with fast fit system;
- Depth adjustable outlet bend;
- Height adjustable from 0 to 200mm;
- 120mm thick.

GENERAL FEATURES

High extraction capacity (80m³/h)

- Removes 30% of odours
- Removes 70% of condensation

- Melanine filter – noise reduction;
- Turns off as soon as the client turns off the switch;
- 220V/50Hz;
- Capacity 65m³/h- 22W 31dB;
- Capacity 80m³/h- 29W 35dB.

GENERAL FEATURES

High extraction capacity (100m³/h)

- Removes 30% of odours
- Removes 70% of condensation

- Melanine filter – noise reduction;
- 960 Lumen LED that can be turn on independently of the extractor;
- Humidity sensor that can be set to automatically turn on;
- Possible to adjust the operating time after the user switches the switch off (2min-20min);
- Capacity 100m³/h- 12W 34dB;
- Capacity 80m³/h- 20W 38dB.

ACCESSORIES



PNEUMATIC CONVERSION KIT

- 2 pneumatic pipes with 350mm;
- Outlet valve pneumatic anchors;
- Pneumatic bellows.

CODE	DESCRIPTION
601527	Pneumatic conversion kit OLI74 PLUS



ELECTRONIC CONVERSION KIT

- Pre-installation of the electronic connection is needed;
- Transformer is not supplied.

CODE	DESCRIPTION
077754	Electronic conversion kit OLI74 PLUS



FLOW RATE REDUCER

- Can be installed after the cistern inside the wall.

CODE	DESCRIPTION
106572	Flow rate reducer for OLI In-wall cisterns



HYDROBOOST CONVERSION KIT

- Uses the energy of water in motion;
- No need to connect to the power grid;
- Suitable for intensive use.

CODE	DESCRIPTION
878285	Hydroboost conversion kit OLI74 PLUS



AC CONVERSION KIT

- Pre-installation of the electronic connection is needed;
- Transformer is supplied.

CODE	DESCRIPTION
878292	AC conversion kit OLI 74 PLUS



AMBIWAVE

- Liquid disinfectant for toilet;
- 450ml dosage;
- 12 units per pack.

CODE	DESCRIPTION
879955	Ambiwave-OLIpure



ACCOUSTIC INSULATION FOR WALL HUNG TOILET AND BIDET

- Acoustic insulation in expanded polyethylene;
- Avoids direct contact between the sanitaryware and the tile.

CODE	DESCRIPTION
620071	Acoustic insulation



OLIPURE KIT

- Compatible with Glam and Narrow flush plates.

CODE	DESCRIPTION
882129	OLIpure kit



BYPASS CONNECTOR

- Connector between the outlet pipe and the outlet bend;
- The flushing can be tested before toilet installed.

CODE	DESCRIPTION
885233	Bypass connector



LONGER SLEEVES FOR WALL HUNG TOILETS

- Outlet pipe Ø90xØ125x300;
- Rubber seal for outlet pipe Ø125;
- Connection WC pipe Ø45x280;
- Rubber seal for WC pipe Ø45;
- M12x300 rods for wall-hung toilets fixation;
- Counter plate fixation screws;
- Toilet fixing material.

CODE	DESCRIPTION
011229	Longer sleeves for wall-hung toilets



ECCENTRIC SET CONNECTION 25MM

- Accessory sets to enable the correction of incorrect applications;
- Toilet connection Ø90;
- Connection WC pipe Ø45x180.

CODE	DESCRIPTION
885108	Eccentric set connection 25mm



DOUBLE OUTLET BEND

- Double outlet bend for wall-hung toilets with horizontal installation.

CODE	DESCRIPTION
622022	Double HPDE WC outlet bend D1 - Ø90, D2 - Ø110



TOILET CONNECTION PIPE

- Outlet pipe Ø90xØ125x250;
- Rubber seal for outlet pipe Ø125;
- Connection WC pipe Ø45x180;
- Toilet fixing material.

CODE	DESCRIPTION
622501	Toilet connection pipe



PP OUTLET BEND ADAPTOR

- Connection Ø90/110.

CODE	DESCRIPTION
086360	PP Adaptor Ø90/110



FOOT EXTENSION S90 OL174 PLUS

- Foot extension set 300mm;
- Solution to increase height adjustment.

CODE	DESCRIPTION
885109	Foot extension set 300mm



DRY WALL FIXING KIT

- Fixation kit for OLI74 PLUS;
- 1 Clamp;
- 2 Support fixation.

CODE	DESCRIPTION
216640	Fixation kit for OLI74 PLUS



WC OUTLET BEND

- WC outlet bend for wall-hung toilets;
- L:300mm;
- Exit Ø110;
- Toilet connection Ø90.

CODE	DESCRIPTION
622002	HDPE wc outlet bend 110



HAPPY AIR KIT PLUS

- Transform any OLI74 PLUS concelead cisterns with this KIT;
- 1 Outlet pipe connection;
- 1 Happy Air fan Plus.

CODE	DESCRIPTION
884340	Happy Air Plus kit OLI74 Plus



HAPPY AIR KIT

- Transform any OLI74 PLUS concelead cisterns with this KIT;
- 1 Outlet pipe connection;
- 1 Happy Air fan.

CODE	DESCRIPTION
884339	Happy Air kit OLI74 Plus

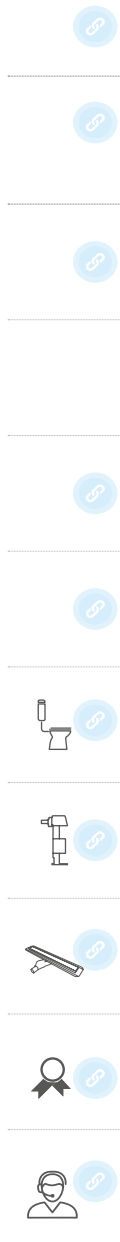

PART NUMBER GUIDE

	 Mechanic	 4/2L	 2 inlet valves	 4/2L 2 inlet valves	 OLIpure	 Pneumatic	 Electronic	 Hydroboost	 AC	 HAPPY AIR
OLI74 PLUS Direct 	Azor Plus 601601 Nano Plus 885068	601603	877961	880789	880782	Azor Plus 601602 Nano Plus 884203	077715	878838	878624	-
OLI74 PLUS Simflex 	Azor Plus 601901 Nano Plus 885069	216251	878929	880790	880783	Azor Plus 002332 Nano Plus 884228	077736	878839	878625	-
OLI74 PLUS S90 Sanitarblock 	Azor Plus 601803 Nano Plus 883134	Azor Plus 216248 Nano Plus 885056	Azor Plus 880799 Nano Plus 885057	880792	880784	Azor Plus 187649 Nano Plus 884235	187650	878840	878655	-
OLI74 PLUS Sanitarblock 	Azor Plus 601821 Nano Plus 885064	216249	879085	880791	880785	002333	077746	878841	878626	048590 Fan 880376 Fan Plus 880377
OLI74 PLUS Free-standing 	601822	216247	879089	880793	880786	002488	077752	878842	878627	
OLI74 PLUS Free-Standing Double 	Azor Plus 600859 Nano Plus 885061	-	-	-	-	-	-	-	-	-

WxDxH	Weight	Qt.	Multiple Box Dim	Weight	Qty per Pallet	Pallet Height	Pallet Width	Pallet Length	Weight
586x126x680	3.51	-	-	-	36	2.24	0.8	1.2	137.16
910x150x640	6.66	-	-	-	26	2.23	0.91	1.28	198.26
805x146x640	6.86	-	-	-	20	2.35	0.8	1.2	155.43
286x205x610	14.08	-	-	-	16	2.23	0.84	1.2	248.61
286x205x610	16.58	-	-	-	16	2.23	0.84	1.2	289.79
1305x306x670	33.85	-	-	-	7	2.38	0.8	1.3	258.86





Lower application and additional top actuation

In-wall cisterns for bathrooms with toilets under the windows or attics

EXPERT PLUS

MORE STORAGE IN THE BATHROOM.

EXPERT PLUS is ideal for applications at window sill level and other low applications (attic, balconies or under the stairs) in solid walls and drywalls. Flush plates can be installed on top or on the front of the cistern.

Usually the space above the toilet is more difficult to use. Build a shelf is an ingredient in creating a modern, organized bathroom, no matter what size it is.



Compatibility Wide range of flush plates



Less is more





721705
EXPERT PLUS Pneumatic Sanitarblock
820

EXPERT PLUS

10

10 YEAR WARRANTY



APPLICATION

Lower application and additional top actuation

POLYPROPYLENE (PP)

Highly resistant cistern inalterable to thermal stress



PLUS

Delayed refill system



OLIpure

Cleans and sanitizes the toilet

OUTLET BEND

Fine adjustment of the outlet bend



HEIGHT ADJUSTABLE

in 200mm



FLUSH PLATE

Wide range of flush plates and actuations: mechanical, pneumatic, electronic and No-Touch

SILENT VALVE

CLASS 1 CERTIFIED



FLUSH VOLUME

Dual flush: 6/3 litres. Adjustable to 4/2 or 7/3 litres

INSTALLATION SYSTEM



Solid wall-brick lined, and all wall-hung toilets



Dry wall, and all wall-hung toilets



SUPPORTS UP TO 400KG





SAFE AND INNOVATIVE SYSTEM
Doesn't contaminate the water or any component inside the cistern - closed system;



USER FRIENDLY
Easy and quick refill;



CONTROLLED DOSING
Releases only 2ml per flush – long lasting;



AMBIWAVE*
450ml dosage.



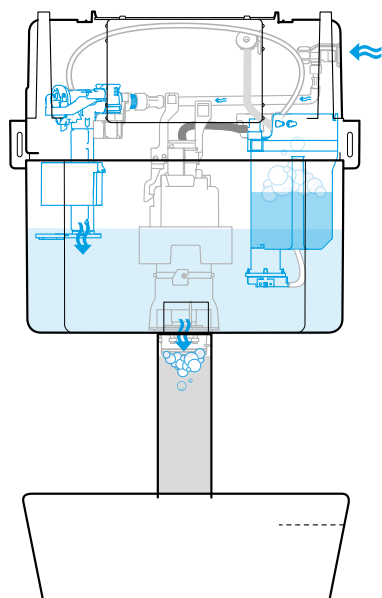

EXPERT PLUS OLIPURE

OLIpure is a self-contained system, placed inside the cistern, where the cleaning liquid is stored. On each flush the disinfectant is dispensed into the toilet, in a control dosage.

This reduces the risk of the disinfectant damaging components in the cistern.

It is compatible with existing WC liquid disinfectants on the market and has a storage capacity of 450ml.

OLIpure is in Expert Plus range and it allows also add to an existing OLI cistern with the OLIpure kit.

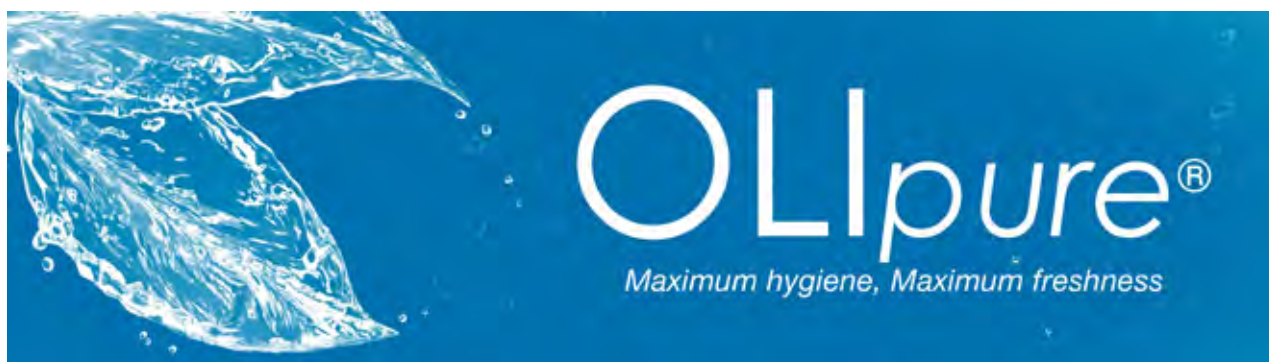

The flush plate range Narrow and Glam of mechanic actuation, are compatible with this sanitizing system. Both hold the opening and closing click system.



AMBIWAVE is the sanitizing liquid included in OLIpure Kit and on the flush plate range Narrow and Glam, however, it is possible to acquire this separately. See page 101.



Just fill the tank with Ambiwave liquid or another toilet liquid on the market*, to keep the toilet clean and with a fresh atmosphere in the bathroom.

*The use of chlorine-free liquid detergents with a viscosity between 150 and 300 cp (at 20 ° C) is recommended.



METAL LINKS

The metal links are fixing supports to rely confidence during the installation of the cistern. Besides ensuring a higher resistance on the fixation, it increase the margin of adjustment according to the wall thickness.

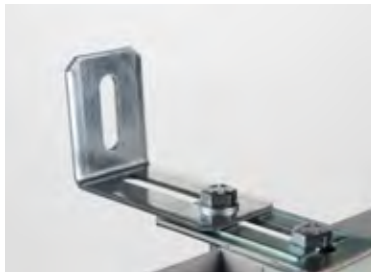

820MM OF HEIGHT

Expert Plus 820mm version guarantees the bathroom installations of toilets under window, stairs or in attic. This reduced height in-wall cistern prove to be reliable: perfect bathrooms with windows over the toilet.

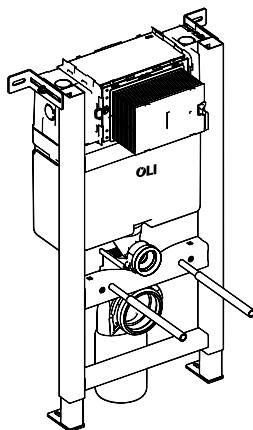

EXPERT PLUS SANITARBLOCK 820

The Sanitarblock installation system is suitable for applications in drywall with load bearing walls. The main advantage of the system is the easiness and speed of safely installing a cistern with a wall-hung toilet.

**FRONT OR TOP ACTUATION
FOR 820 AND 1130 EXPERT
PLUS VERSIONS**

Usually the space above the toilet is more difficult to use. Build a shelf and install a floor mounted toilet or wall-hung toilet. With Expert Plus it is now possible to install the flush plates on the top or in front of the cistern.

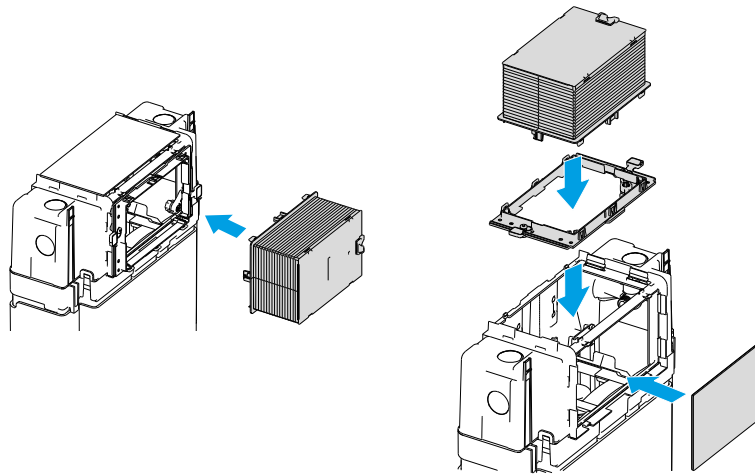

**EXPERT PLUS
DIRECT**

This wall installation system should be selected when installing the cistern in a solid wall that will be brick-lined with a floor-mounted toilet.



**EXPERT PLUS
SIMFLEX 820**

This wall installation system should be selected when installing the cistern in a solid wall that will be brick lined with a wall-hung toilet.



**EXPERT PLUS
FREE-STANDING 820**

The Sanitarblock Free-Standing installation system is used in drywall applications with a wall-hung toilet. The main advantage of the system is the easiness and speed of safely installing a concealed cistern with a wall hung toilet without the need of any type of wall.

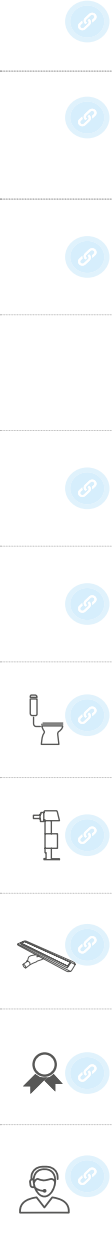



FAST-FIT

Fast-Fit is a system that provides an easy and strong fixation to the load bearing walls.



ADJUSTABLE WASTE PIPE CURVE

Polypropylene curve, that connects the toilet to the waste pipe is adjustable in 45° and also adjustable in depth to match the construction site waste pipe.



**EXPERT PLUS
SANITARBLOCK 1130**

The Sanitarblock installation system is suitable for applications in drywall with load bearing walls. The main advantage of the system is the easiness and speed of safely installing a cistern with a wall-hung toilet.

**FRONT OR TOP ACTUATION
FOR 820 AND 1130 EXPERT
PLUS VERSIONS**

Usually the space above the toilet is more difficult to use. Build a shelf and install a floor mounted toilet or wall-hung toilet. With Expert Plus it is now possible to install the flush plates on the top or in front of the cistern.

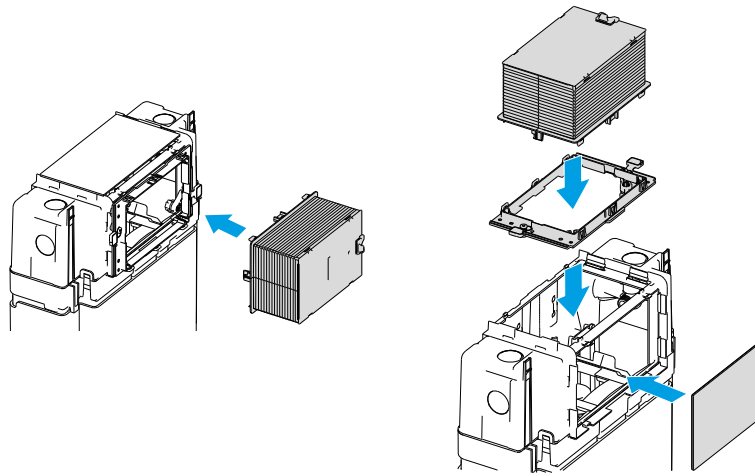

**EXPERT PLUS
SIMFLEX1130**

This wall installation system should be selected when installing the cistern in a solid wall that will be brick lined with a wall-hung toilet.



**EXPERT PLUS
FREE-STANDING 1130**

The Sanitarblock Free-Standing installation system is used in drywall applications with a wall-hung toilet. The main advantage of the system is the easiness and speed of safely installing a concealed cistern with a wall hung toilet without the need of any type of wall.

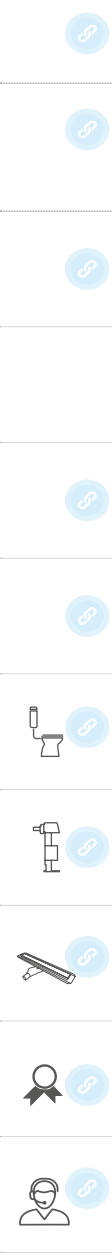

TECHNICAL INFORMATION

EXPERT PLUS

Direct 820

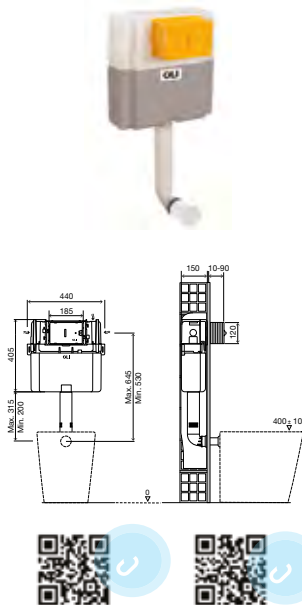

GENERAL FEATURES FOR ALL VERSIONS

- Dual flush 6/3 litre in-wall cistern (adjustable to 4/2 or 7/3 litres);
- Top or front actuation/access;
- Polypropylene (PP) cistern highly resistant and inalterable to thermal stress;
- Mechanic or pneumatic actuation;
- Upon request some versions compliant with:
- SAI-WATERMARK/SINTEF/NF/BELGAQUA certification;
- EN 14055 CE marking;
- Compatible with all floor mounted toilets;
- Solid wall installation;
- Lower/under bench installation possible;
- 150mm thick.

INCLUDED IN ALL VERSIONS

- Wall fixing kit;
- G 1/2" stop valve;
- Inlet and outlet toilet connection;
- Toilet fixing material (when applicable);
- Outlet bend and Ø90/110 adaptor (when applicable).



EXPERT PLUS

Simflex 820

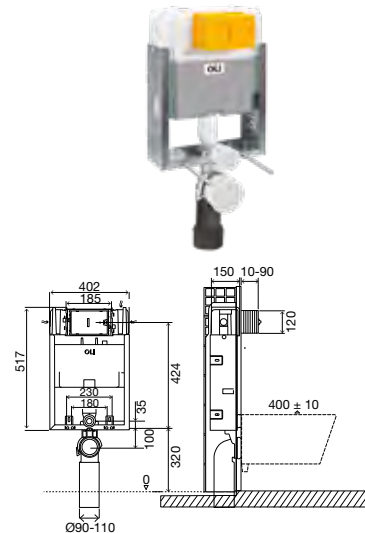

SPECIFIC FEATURES

- Compatible with all wall-hung toilets;
- Solid wall installation;
- Lower/under bench installation possible;
- 150mm thick.

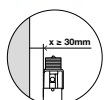
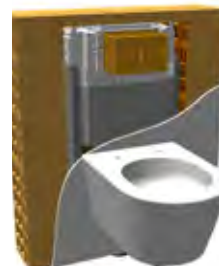
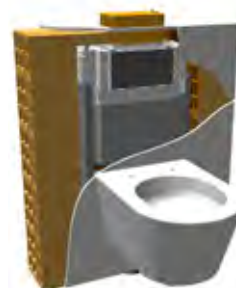

EXPERT PLUS

Sanitarblock 820

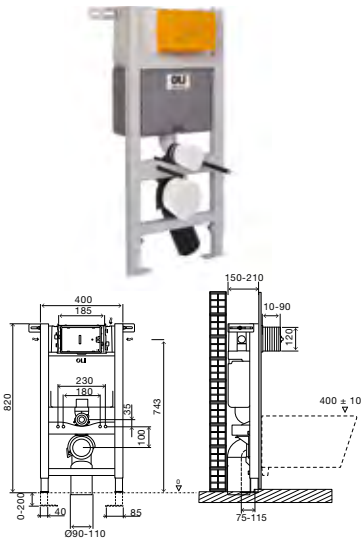

SPECIFIC FEATURES

- Compatible with all wall-hung toilets;
- Solid wall or drywall installation;
- Frame tested for a 400kg load;
- Easy and quick installation;
- Height adjustable from 0 to 200mm;
- Depth adjustable outlet bend;
- Lower/under bench installation possible;
- 150mm thick.

EXPERT PLUS

Free-standing 820

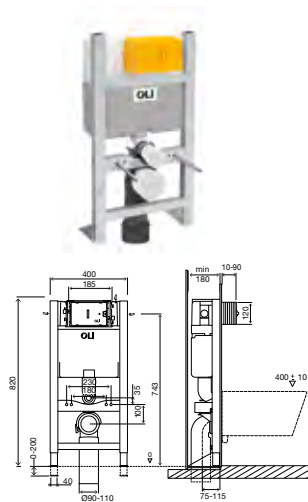

SPECIFIC FEATURES

- Compatible with all wall-hung toilets;
- Drywall installation;
- Frame tested for a 400kg load;
- Height adjustable from 0 to 200mm;
- Depth adjustable outlet bend;
- Lower/under bench installation possible;
- 180mm thick.



EXPERT PLUS

Simflex 1130

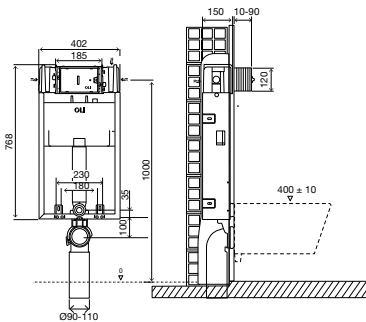

GENERAL FEATURES FOR ALL VERSIONS

- Dual flush 6/3 litre in-wall cistern;
- Top or front actuation/access;
- Solid wall installation;
- Polypropylene (PP) cistern highly resistant and inalterable to thermal stress;
- Mechanic or pneumatic actuation;
- Upon request some versions compliant with:
 - SAI-WATERMARK/SINTEF/NF/
 - BELGAQUA certification;
 - EN 14055 CE marking;
- Compatible with all floor mounted toilets;
- 150mm thick.

INCLUDED IN ALL VERSIONS

- Wall fixing kit;
- G 1/2" stop valve;
- Inlet and outlet toilet connection;
- Toilet fixing material (when applicable);
- Outlet bend and Ø90/110 adaptor (when applicable).



EXPERT PLUS

Sanitarblock 1130

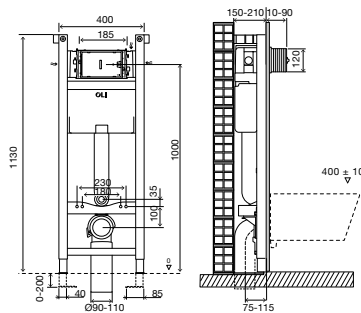

SPECIFIC FEATURES

- Compatible with all wall-hung toilets;
- Solid wall or drywall installation;
- Frame tested for a 400kg load;
- Easy and quick installation with fast fit system;
- Height adjustable from 0 to 200mm;
- Depth adjustable outlet bend;
- 150mm minimum thick.



EXPERT PLUS

Free-standing 1130

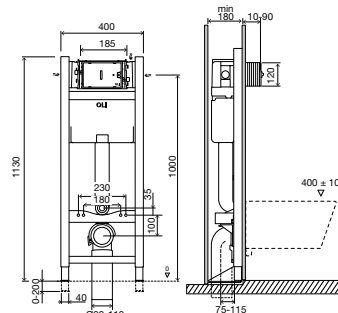

SPECIFIC FEATURES

- Compatible with all wall-hung toilets;
- Drywall installation;
- Frame tested for a 400kg load;
- Height adjustable from 0 to 200mm;
- Depth adjustable outlet bend;
- Lower/under bench installation possible;
- 180mm minimum thick.

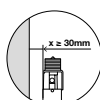

ACCESSORIES



PNEUMATIC CONVERSION KIT

- 2 pneumatic pipes with 350mm;
- Outlet valve pneumatic anchors;
- Pneumatic bellows.

CODE	DESCRIPTION
035148	Pneumatic conversion kit EXPERT PLUS



MECHANIC CONVERSION KIT

- Outlet valve mechanical anchors;
- Levers set.

CODE	DESCRIPTION
030497	Mechanic conversion kit EXPERT PLUS



FLOW RATE REDUCER

- Can be installed after the cistern inside the wall.

CODE	DESCRIPTION
106572	Flow rate reducer for OLI In-wall cisterns

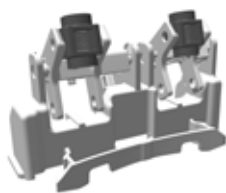

MECHANIC CONVERSION KIT FOR TOP ACTUATION

- Compatible with top actuation flush plates: Glam, Narrow, Globe and Plain.

CODE	DESCRIPTION
211743	Mechanic conversion kit EXPERT PLUS top actuation



OLIPURE KIT

- Compatible with Glam and Narrow flush plates.

CODE	DESCRIPTION
882129	OLIpure Kit



AMBIWAVE

- Liquid disinfectant for toilet;
- 450ml dosage;
- 12 units per pack.

CODE	DESCRIPTION
879955	Ambiwave-OLIpure



SANITARBLOCK CORNER KIT

- Ideal for corner application;
- Compatible with 1150 and 1130mm sanitarblock frames.

CODE	DESCRIPTION
719183	Sanitarblock corner kit



ECCENTRIC SET CONNECTION 25MM

- Accessory sets to enable the correction of incorrect applications.
- Toilet connection Ø90;
- Connection WC pipe Ø45x180.

CODE	DESCRIPTION
885108	Eccentric set connection 25mm



BYPASS CONNECTOR

- Connector between the outlet pipe and the outlet bend;
- The flushing can be tested before toilet installed.

CODE	DESCRIPTION
885233	Bypass connector

PART NUMBER GUIDE

	 Mechanic	 4/2L	 2 inlet valves	 4/2L 2 inlet valves	 OLIpure	 Pneumatic
EXPERT PLUS Direct 	020684	-	-	-	152966	018223
EXPERT PLUS Simflex 820 	076456	-	-	-	152967	141960
EXPERT PLUS Sanitarblock 820 	Azor Plus 721703 Nano Plus 885065	-	-	-	880787	Azor Plus 721705 Nano Plus 885067
EXPERT PLUS Free-standing 820 	014092	-	-	-	880788	048375
EXPERT PLUS Simflex 1130 	014095	-	-	-	-	-
EXPERT PLUS Sanitarblock 1130 	014089	-	-	-	-	-
EXPERT PLUS Free-standing 1130 	014091	-	-	-	-	-

WxDxH	Weight	Qt.	Multiple Box Dim	Weight	Qty per Pallet	Pallet Height	Pallet Width	Pallet Length	Weight
566x166x545	3.45	-	-	-	35	1.96	0.9	1.2	133.46
785x440x170	7.31	-	-	-	30	2.36	0.8	1.2	245.56
845x191x525	10.90	-	-	-	24	2.26	0.85	1.2	284.95
845x191x525	15.2	-	-	-	24	2.26	0.85	1.2	364.85
805x166x580	-	-	-	-	21	1.9	0.83	1.2	226.39
1165x186x445	12.2	-	-	-	16	1.94	0.8	1.2	218.00
1165x186x445	15.96	-	-	-	16	1.94	0.8	1.2	277.88



QUADRA PLUS fits
practically anywhere.

Now, for small bathrooms, there
is a corner flush cistern that
could be the ideal solution



154962
SLIM Gold plated

QUADRA PLUS

FOR SMALL SPACES, OLI HAS THE SOLUTION.

Essentially it fits practically anywhere thanks to its 300mm reduced width. As a complement, OLI provides a corner kit for corner toilets (see Accessories) to open up the bathroom space.

Compatibility

Wide range of flush plates



Glam



Metal



Ria Stop



Plain

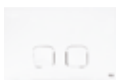

Globe



Narrow



Slim



Ria



iPlate



River



Oceania



Ino-x



Less is more



Blink



Salina



Easy Dual



SM15



Trumpet



Oceania



Karisma





070826
PLAIN White

135974
QUADRA PLUS Mechanic Sanitarblock

QUADRA PLUS

10

..... 10 YEAR WARRANTY

 FAST-FIT SYSTEM

 IDEAL FOR CORNER APPLICATION

 PLUS
Delayed refill system

POLYPROPYLENE (PP)
Highly resistant cistern inalterable to thermal stress

FITS PRACTICALLY ANYWHERE

OUTLET BEND
Fine adjustment of the outlet bend



FLUSH PLATE
Wide range of flush plates

 **FLUSH VOLUME**
Dual flush: 6/3 litres

INSTALLATION SYSTEM
 Solid wall-brick lined, and all wall-hung toilets

 Dry wall, and all wall-hung toilets

 **HEIGHT ADJUSTABLE**
in 200mm





QUADRA PLUS SANITARBLOCK

The Sanitarblock installation system is suitable for applications in drywall with load bearing walls. The main advantage of the system is the easiness and speed of safely installing a cistern with a wall-hung toilet.



REDUCED DIMENSIONS

Quadra Plus, thanks to its 300mm reduced width, fits in all bathrooms.



FAST-FIT

Fast-Fit is a system that provides a fixation to the load bearing walls and allows for a fast and precise levelling of the frame.



CORNER KIT

With acquisition of corner kit, Quadra Plus is ideal for corner toilets. See page 111.

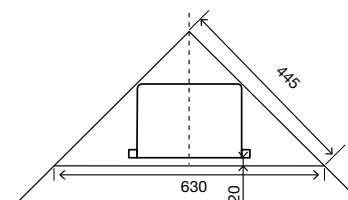



QUADRA PLUS DIRECT

This wall installation system should be selected when installing the cistern in a solid wall that will be brick-lined with a floor mounted toilet.



QUADRA PLUS FREE-STANDING

The Sanitarblock free-standing installation system is used in drywall applications with a wall-hung toilet. The main advantage of the system is the easiness and speed of safely installing a concealed cistern with a wall hung toilet without the need of any type of wall.



TECHNICAL INFORMATION

QUADRA PLUS

Direct

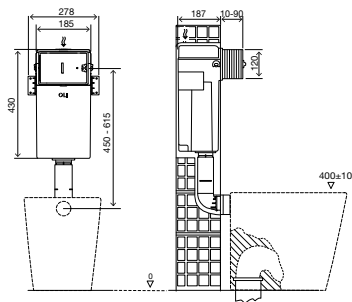

GENERAL FEATURES FOR ALL VERSIONS

- Dual flush 6/3 litre in-wall cistern;
- Compatible with Pneumatic buttons;
- Polypropylene (PP) cistern highly resistant and inalterable to thermal stress;
- Upon request some versions compliant with: NF certification;
- 270 mm reduced width;
- EN 14055 CE marking;
- Compatible with all floor mounted toilets;
- Solid wall installation;
- 187 mm thick.

INCLUDED IN ALL VERSIONS

- 315mm flush pipe;
- G 1/2" stop valve;
- WC connection pipe Ø45 .



QUADRA PLUS

Sanitarblock

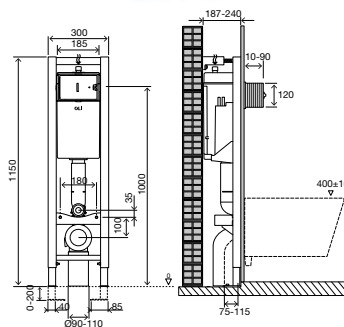

SPECIFIC FEATURES

- Compatible with wall-hung toilets with a 180mm fixation length;
- Solid wall or drywall installation;
- Frame tested for a 400kg load;
- Easy and quick installation with Fast-Fit system;
- Depth adjustable outlet bend;
- Height adjustable from 0 to 200mm;
- 300mm reduced width;
- 187mm thick.



QUADRA PLUS

Free-standing

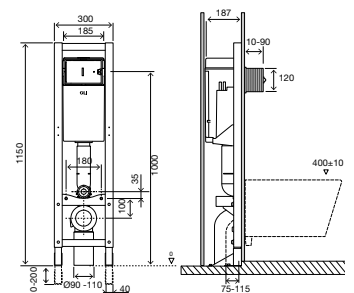

SPECIFIC FEATURES

- Compatible with wall-hung toilets with a 180mm fixation length;
- Drywall installation;
- Frame tested for a 400kg load;
- Easy and quick installation;
- Depth adjustable outlet bend;
- Height adjustable from 0 to 200mm;
- 300mm reduced width;
- 187mm thick.



ACCESSORIES

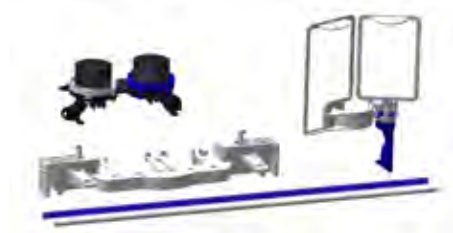

PNEUMATIC CONVERSION KIT

- 2 pneumatic pipes with 2.5m;
- Outlet valve pneumatic anchors;
- Pneumatic bellows.

CODE	DESCRIPTION
101773	Pneumatic conversion kit QUADRA PLUS



ECCENTRIC SET CONNECTION 25MM

- Accessory sets to enable the correction of incorrect applications;
- Toilet connection Ø90;
- Connection WC pipe Ø45x180.

CODE	DESCRIPTION
885108	Eccentric set connection 25mm



SANITARBLOCK CORNER KIT

- Ideal for corner application;
- Compatible with 1150 and 1130mm sanitarblock frames.

CODE	DESCRIPTION
719183	Sanitarblock corner kit



WC OUTLET BEND

- WC outlet bend for wall-hung toilets;
- L:300mm;
- Exit Ø110;
- Toilet connection Ø90.

CODE	DESCRIPTION
622002	HDPE WC outlet bend Ø110



ACCOUSTIC INSULATION FOR WALL HUNG TOILET AND BIDET

- Accoustic insulation in expanded polyethylene;
- Avoids direct contact between the sanitaryware and the tile.

CODE	DESCRIPTION
620071	Accoustic insulation



FLEXIBLE PIPE EXTENSION 613mm

- The solution to overcome obstacles;
- For EXPERT and QUADRA PLUS an additional flush pipe is needed (Code 021266).

CODE	DESCRIPTION
622401	Flexible flush pipe extension

PART NUMBER GUIDE

	 Mechanic	 4/2L	 2 inlet valves	 4/2L 2 inlet valves	 OLIpure	 Pneumatic
QUADRA PLUS Direct 	720002	-	-	-	-	037172
QUADRA PLUS Sanitarblock 	Azor Plus 135974 Nano Plus 885060	-	-	-	-	Azor Plus 141945 Nano Plus 885058
QUADRA PLUS Free-standing 	722021	-	-	-	-	187103

WxDxH	Weight	Qt.	Multiple Box Dim	Weight	Qty per Pallet	Pallet Height	Pallet Width	Pallet Length	Weight
286x205x610	3.88	-	-	-	64	2.6	0.82	1.2	265.13
1179x228x340	11.5	-	-	-	21	2.22	0.8	1.2	267.12
1179x228x340	12.65	-	-	-	20	2.42	0.8	1.2	280.34

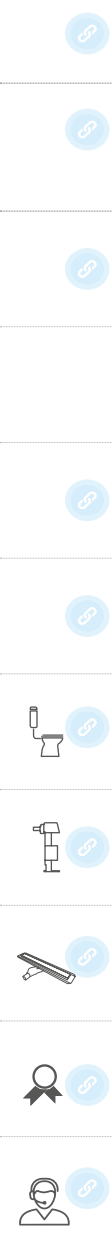



Where trust matters

For bathrooms with clean design,
having in-cisterns for wall hung
toilets.

659046
SLIM Matt chrome

OLI80

IN-WALL CISTERN RANGE THAT IS MADE OF SIMPLICITY AND RELIABLE.

OLI80 is a great option to equip a bathroom with in-wall cistern. It is suitable for all solid walls and also for squat toilet that essentially is a toilet at floor level.



Projects



GOLDEN TOWER, JEDDAH, SAUDI ARABIA

The building with a high standard of luxury in Jeddah, Saudi Arabia, has OLI in-wall cisterns. The Golden Tower, a high-end residential were equipped with the in-wall cistern OLI80.

With 49 floors and 225 meters above the ground, the Golden Tower stands out for being a building with a bold design and according to the consortium responsible for the project, "combines modernity and the traditional architecture of Saudi Arabia".

Compatibility Range of flush plates



Metal



Ria Stop



Ria



iPlate



River



Slim





638506
RIVER Matt chrome

OLI80

FAST-FIT SYSTEM

10 10 YEAR WARRANTY

€ COST-BENEFIT RANGE

+ **-** FLUSH VOLUME
Dual flush: 6/3 adjustable to 4.5L/3L

POLYPROPYLENE (PP)
highly resistant cistern
inalterable to thermal stress

INSTALLATION SYSTEM

OUTLET BEND
Fine adjustment of the outlet bend

ONE MAN ASSEMBLY

Solid wall-brick lined, and all floor toilets

Solid wall-brick lined, and all wall-hung toilets

HEIGHT ADJUSTABLE
in 200mm

EN 14055 CE MARKING

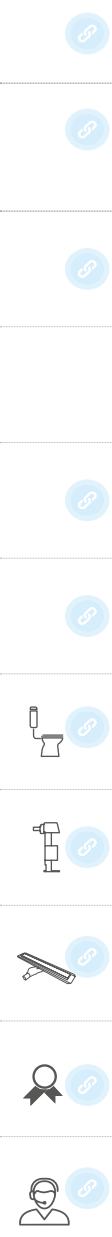



OLI80 DIRECT

This wall installation system should be selected when installing the cistern in a solid wall that will be brick-lined with a floor-mounted toilet.



OLI80 SIMFLEX

This wall installation system should be selected when installing the cistern in a solid wall that will be brick lined with a wall-hung toilet.



OLI80 SANITARBLOCK

The Sanitarblock installation system is suitable for applications in drywall with load bearing walls. The main advantage of the system is the easiness and speed of safely installing a cistern with a wall-hung toilet.



OLI80 SQUAT PAN

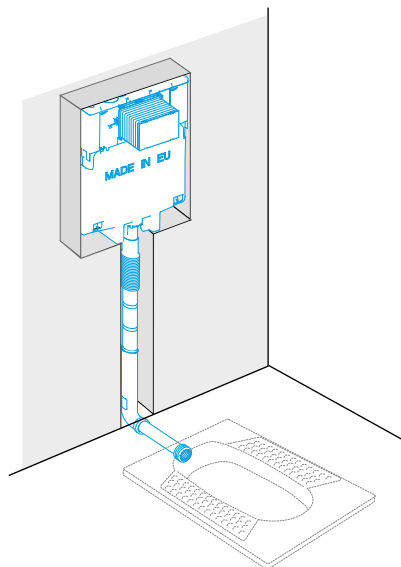

This wall installation system should be selected when installing the cistern in a solid wall with a squat pan, a toilet at floor level.



SALT WATER IN THE IN-WALL CISTERNS?

The use of salt water in the bathroom can help to better distribute the scarcest resource of the planet.



Through a partnership with John Guest, OLI80 Seawater Sanitarblock includes all the components without metal, from the racord, to the flexible and even the stop valve.



OLI80 SEAWATER SANITARBLOCK

The rigorous production process combined with OLI's hydric sustainable focus, are base for all of the company cistern development effort.

OLI80 go through rigorous quality tests, with 200.000 flushing cycles, before reach seawater version. These tests were conducted in OLI's Life-Time Test Lab who guarantees the functional parameters before going to market.

The functionality has to be ensured by increased maintenance (risk of corrosion).



TECHNICAL INFORMATION

OLI80

Direct

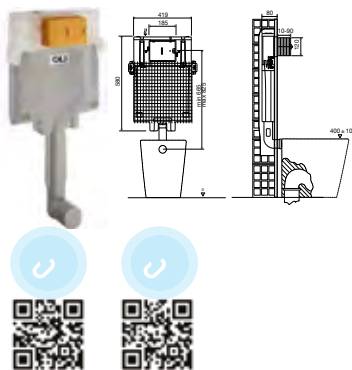

GENERAL FEATURES FOR ALL VERSIONS

- Dual flush 6/3 litre in-wall cistern (adjustable to 4.5/3 litres);
- Polypropylene (PP) cistern highly resistant and inalterable to thermal stress;
- Mechanical actuation;
- Upon request some versions compliant with: BELGAQUA certification;
- EN 14055 CE marking;
- Compatible with all floor mounted toilets;
- Solid wall installation;
- 80mm thick.

INCLUDED IN ALL VERSIONS

- 360mm flush pipe included;
- Wall fixing kit;
- Net for easier mortar adhesion;
- G 1/2" stop valve;
- WC connection pipe Ø45 .



OLI80

Squat pan

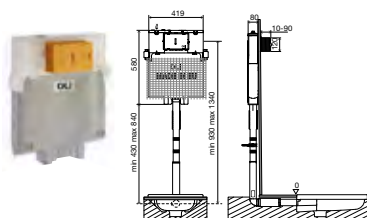

SPECIFIC FEATURES

- Compatible with all toilet at floor level or floor mounted;
- Flexible pipe included;
- Flexible pipe height 430 to 840mm;
- Solid wall installation;
- 80mm thick.



OLI80

Simflex

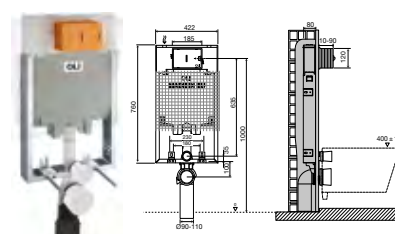

SPECIFIC FEATURES

- Compatible with all wall-hung toilets;
- Solid wall installation;
- 80mm thick.



ACCESSORIES

OLI80 Sanitarblock

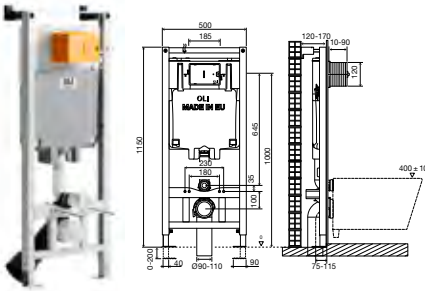

FLOW RATE REDUCER

- Can be installed after the cistern inside the wall.

CODE	DESCRIPTION
106572	Flow rate reducer for OLI In-wall cisterns

SPECIFIC FEATURES

- Wall hung toilets up to 660mm long;
- Frame tested for a 400kg load;
- Depth adjustable outlet bend;
- Easy and quick installation with fast fit system;
- Height adjustable from 0 to 200mm;
- One man assembly;
- Solid wall or drywall installation;
- 120mm thick.



FLEXIBLE PIPE EXTENSION 613mm

- The solution to overcome obstacles.

CODE	DESCRIPTION
622401	Flexible flush pipe extension



















FLOOR SUPPORT SYSTEM FOR SIMFLEX FRAMES

- Compatible with OLI Simflex frames;
- Fixing material included.

CODE	DESCRIPTION
059272	Floor support system with lateral fixation for Simflex frames x2

PART NUMBER GUIDE

	 Mechanic	 4/21	 2 inlet valves	 4/2L 2 inlet valves	 OLIpure	 Pneumatic	 Electronic	 Hydroboost	 AC	 HAPPY AIR	 Seawater
OLI80 Direct 	Azor 600051 Nano 885070	-	-	-	-	-	-	-	-	-	-
OLI80 Squat pan 	Azor 45058 Nano 885112	-	-	-	-	-	-	-	-	-	-
OLI80 Simflex 	Azor 600251 Nano 885110	-	-	-	-	-	-	-	-	-	-
OLI80 Sanitarblock 	Azor 600151 Nano 885111	-	-	-	-	-	-	-	-	-	-
OLI80 Sanitarblock Salty water 	-	-	-	-	-	-	-	-	-	-	885232

WxDxH	Weight	Qt.	Multiple Box Dim	Weight	Qty per Pallet	Pallet Height	Pallet Width	Pallet Length	Weight
625x117x670	3.68	-	-	-	60	2.19	1.25	1.3	249.60
625x117x670	3.99	-	-	-	60	2.19	1.25	1.3	268.8
915x166x565	6.84	-	-	-	22	1.99	0.9	1.2	174.1938
1180x140x530	13.17	-	-	-	20	2.35	0.8	1.2	289.15
1180x140x530	13.17	-	-	-	20	2.35	0.8	1.2	289.15

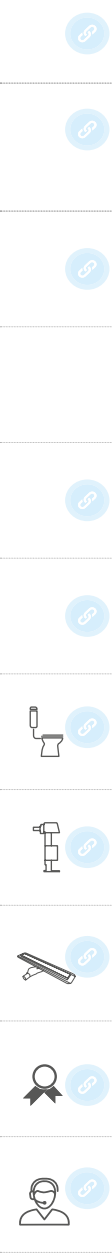

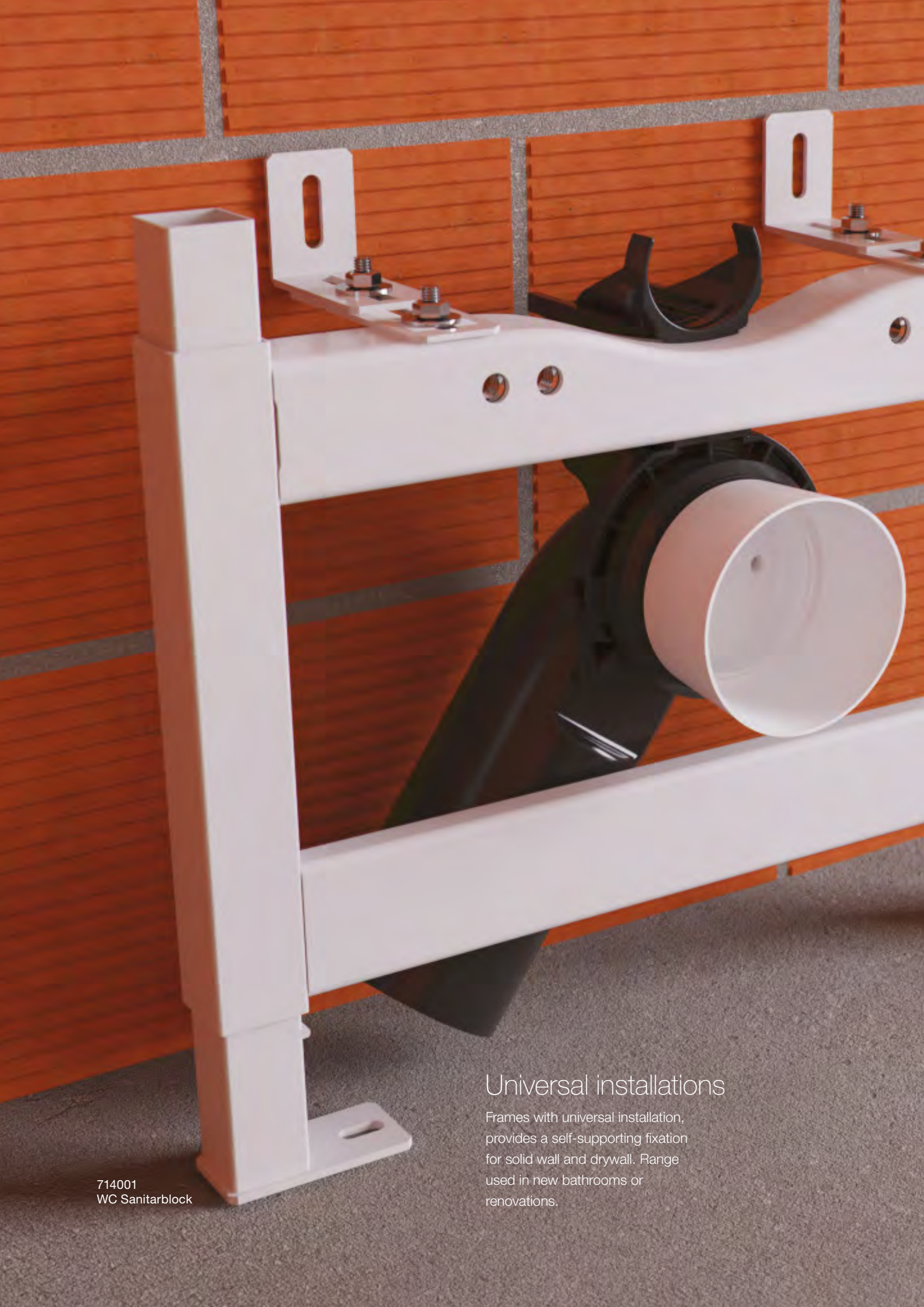

714001
WC Sanitarblock

Universal installations

Frames with universal installation, provides a self-supporting fixation for solid wall and drywall. Range used in new bathrooms or renovations.

FRAMES

IN-WALL FRAMES FOR EVERY CERAMIC SANITARY WARE

OLI offers frames which grant safety on the use of wall hung sanitary ware. From toilets, urinals, bidet or washbasin, any sanitary ware can be installed in masonry walls or plasterboard walls.

It's directly from OLI factory that these frames come equip with all additional accessories such as the waste pipe, adaptor and all the fixation materials for the frame and sanitary ware.



WC

In toilet's frames range, OLI offers the following versions: sanitarblock, 4 fixations points sanitarblock, free-standing e 4 fixations points free-standing.

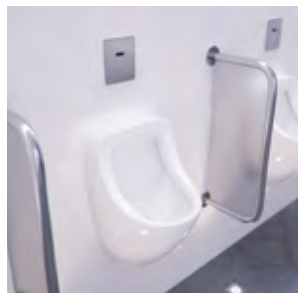

URINAL

In urinal's frames range, OLI offers a wide range of solutions, including frames for wall-hung urinal dividers. Light versions compatible for drywalls to urinal frames with height adjustable are also OLI's solutions.



BIDET

The range of bidet's frames combines different products according to the type of installation. OLI offers the Simflex and Sanitarblock versions to adjust to all types of installation in solid wall or drywall.



WASHBASIN

In washbasin's frames range, OLI offers the Simflex version, with 4 fixations for solid walls and the Sanitarblock version with height adjustable compatible for solid walls and drywalls.

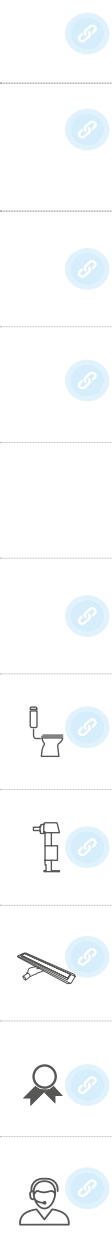



WC

Sanitarblock

To ensure the highest levels of quality, OLI test its frames to support a maximum of 400 kg. The WC Sanitarblock Frame, not only been tested, it also includes a possible adjustment in height up to 200mm to match any toilet in the market. The installation can be made in masonry walls or technical frames.



WC

Free-Standing

Suitable for the installation of wall-hung toilets in technical frames as the frame is only fixated to the floor. The advantage of being tested for 400kg assures the reliability of the frame upon installation.



4 WC FIXATION POINTS

Free-Standing

The WC 4 Fixation Points Free-Standing stands out for its compatibility with 4 fixation point toilets and by including a axial seal. Reliable and adjustable, this frame stands up to a maximum of 400 kg and includes a possible adjustment up to 200mm.



WC FRAME

For flush valve

the frame is suitable for the installation of wall hung toilets equip with fluxometers in masonry walls or plasterboard walls. On Sanitarblock version, this frame comes equip with Fast-Fit system for a quick installation to the wall of the bathroom as well as a adjustable height of 200mm.



FLUXOMETER OR FLUSH PLATE

Compatible with all fluxometers or flush plates of the market. It comes with a wooden plate made of marine plywood for its fixation.



FAST-FIT

Fast-Fit is a system that provides a fixation to the load bearing walls and allows for a fast and precise levelling of the frame.



ADJUSTABLE WASTE PIPE CURVE

This Polypropylene curve, allows the connection of the toilet to the waste pipe. Adjustable in 45° and adjustable according to the drill of the waste pipe in the construction site.

Compatibility

BLINK II Flush fluxometer
(See page 171 for more information)





ECO URINAL FRAME

This frame is ideal for all bathroom projects either public or residential. Eco Urinal Frame is compatible with all wall-hung urinals in the market and the installation can be made in solid wall or drywall thanks to its compact dimension and light weight. OLI advises to install the flush valve before closing the wall.



Compatibility

Flush plates compatibility
(see pages 193, 194 and
195 for more information)

SM15 Urinal



BLINK Urinal



eAQUA Urinal



GLOBE Urinal

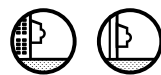

URINAL

Sanitarblock

This frame carries trust and safety at the time to install a wall-hung urinal in bathrooms of masonry walls or technical frame. With its Fast-Fit system, it allows a quicker and easier installation, suitable for any urinal thanks to its adjustable feet up to 200mm. Assembly can be done by only one person, allowing for a fast and precise levelling of the frame.



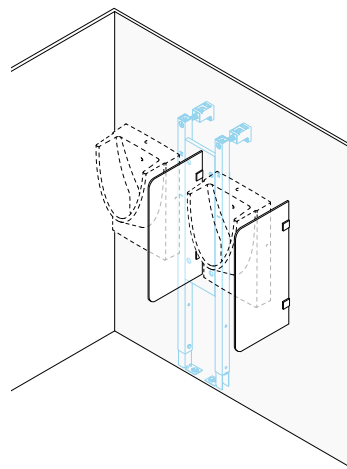

URINAL DIVIDER

The urinal dividers in public bathrooms, are an integral part when projected. OLI offers a divider made in tempered glass with 8mm thickness.



EASY STRUCTURE

Sanitarblock

To ensure the safety and suitable fixation of the urinal dividers, OLI has developed and produced the Easy Sanitarblock frame to offer a complete range of products for any public bathroom. This frame can be installed in masonry wall or technical frames and it also includes Fast-Fit system for a quicker and easier installation.

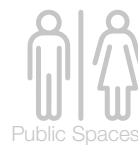



STOP FIRE

One of the main risks of a fire is smoke-inhalation, which can lead to many complications, if not death. Adopt Stop Fire as a crucial part of a fire safety strategy. It prevents the spread of fire and smoke between divisions in a building for approximately 120 minutes. This can be the time needed to fully evacuate everyone safely from the building.

It is compatible to Quadra Plus, OLI120 Plus, OLI74 Plus and Expert Plus (free-standing and sanitarblock).

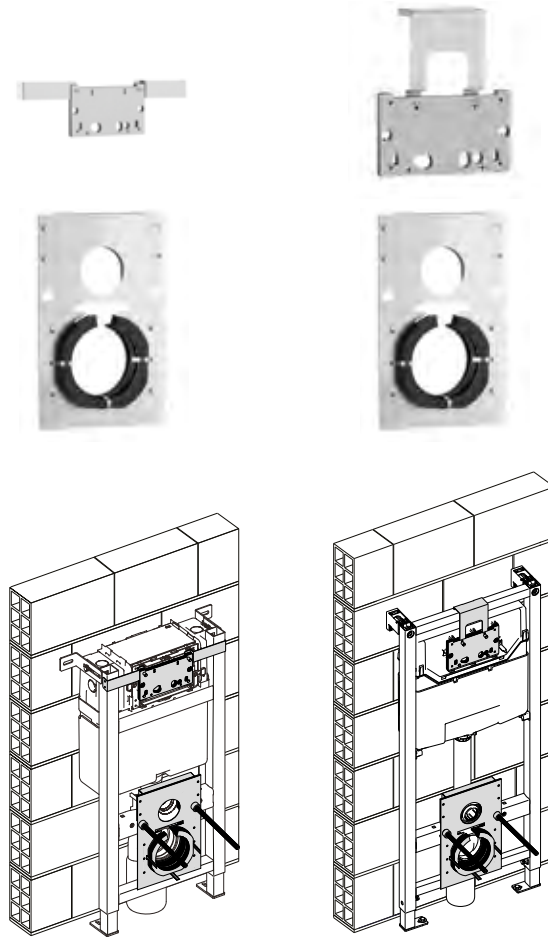

Stop Fire is produced in compliance with the most recent standards. Stop fire works by including “collars” in the openings of the equipment. The “collars” are made of steel and painted with polyester powder fitted with special intumescent inserts which, in the event of fire, expand and squeeze the pipe thus preventing the passage of flames, combustion gas and vapours and acting as a thermal insulation. Fire safety saves lives and Stop Fire can be a defining element of a thorough fire safety strategy.

Product in accordance with EN 13501-2:2016

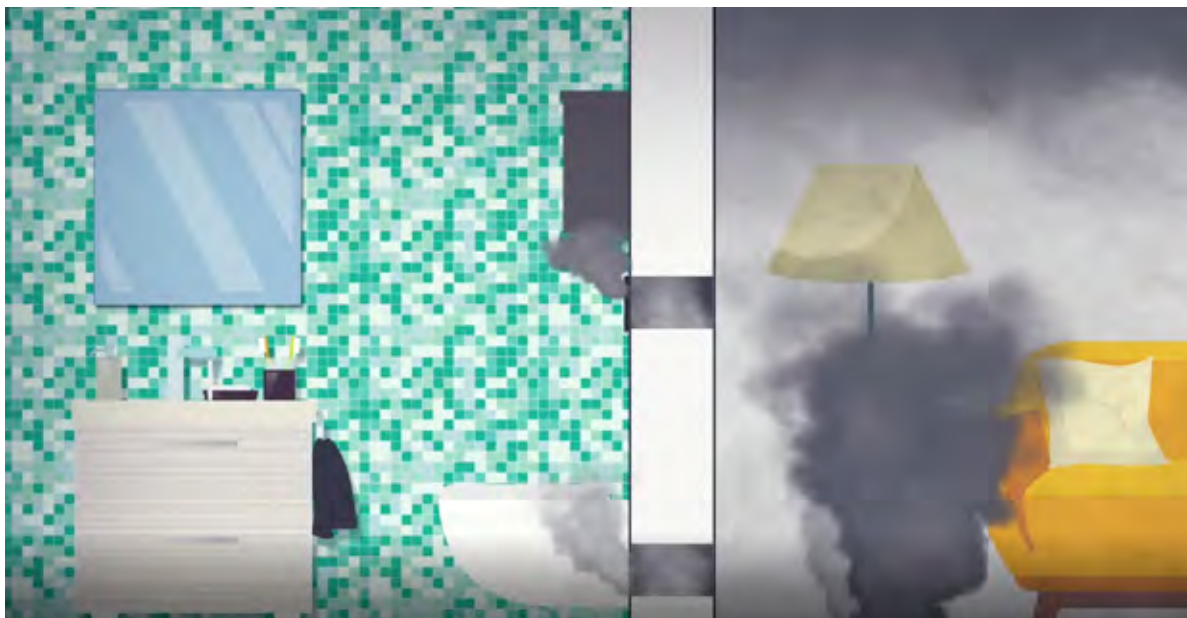



BIDET

Sanitarblock

This frame carries trust and safety at the time to install a wall-hung bidet in bathrooms of masonry walls or technical frame. With its Fast-Fit system, it allows a quicker and easier installation, suitable to any bidet thanks to its adjustable feet up to 200mm.



2 WATER CONNECTIONS

With 2 water connections, this frame main advantage is to suit any bathroom project.



FAST-FIT SYSTEM

Fast-Fit is a system that provides a fixation to the load bearing walls and allows for a fast and precise levelling of the frame.

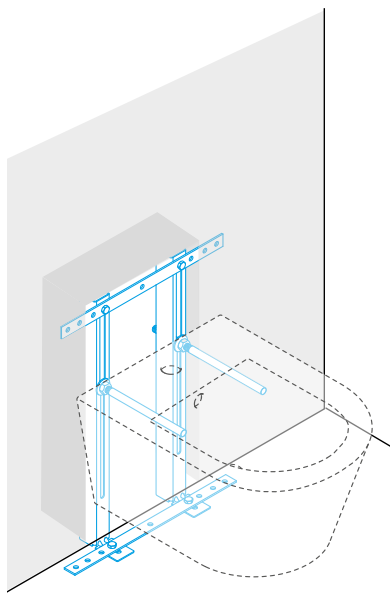

ECO WC/BIDET

Simflex

The installation of this frame, must be made in masonry walls, suitable for wall-hung toilets and wall-hung bidet. The height is adjustable, made in tubular profile, its ideal for projects of bathrooms with limited budget.

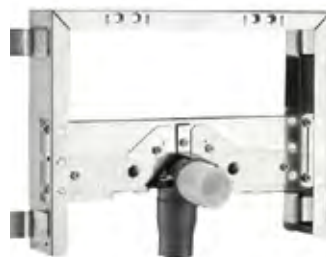

BIDET

Simflex

The galvanized steel of which the frame is made of, assures the durability and the same trust for wall hung bidet. With just 80mm of depth, this is its main advantage for masonry walls where space is limited.



ECO BIDET

Sanitarblock

The Eco Bidet Sanitarblock frame is versatile as it allows to be installed in masonry walls or technical frames, assuring the trust on frames that hold wall-hung bidet.

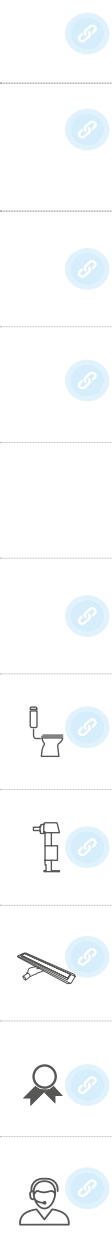

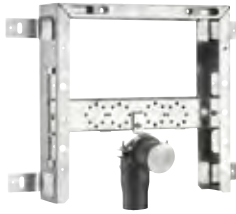

WASHBASIN

Simflex

The galvanized steel of which the frame is made of, assures the durability and the same trust for wall hung bidet. With just 80mm of depth, this is its main advantage for masonry walls where space is limited.



WASHBASIN

Sanitarblock

This is the frame that brings trust and safety when the time comes to install a wall-hung washbasin in bathrooms of masonry wall or technical frame. With Fast-Fit system, the Washbasin Sanitarblock Frame, allows a quicker and easier installation suitable for any washbasin - with or without furniture - thanks to its adjustable feet up to 200mm.



BLOCKADE

According to the scenario of construction site, the fixation feet have 3 positions and a metal blockade to adjust to the intended position.



KIT CONCEALED SIPHON

For washbasin hidden connections $\varnothing 32$, this Kit Concealed Siphon guarantees the maintenance access through magnets.

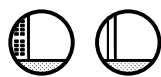
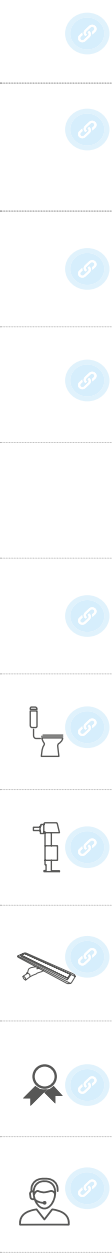

SHOWER FRAME

Sanitarblock

This frame is suitable for showers and built-in taps install in masonry walls or technical frames. the frame is adjustable in height in order to be compatible with the instalment position of the showers and taps.

TECHNICAL INFORMATION

WC

Sanitarblock

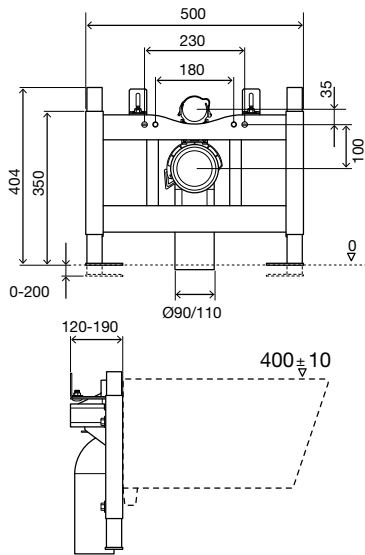

WC

Free-standing

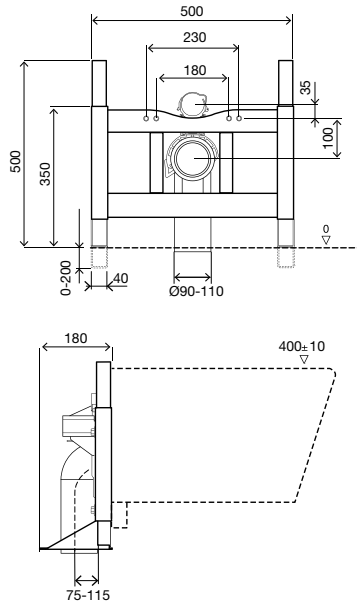

4 WC FIXATION POINTS

Free-standing

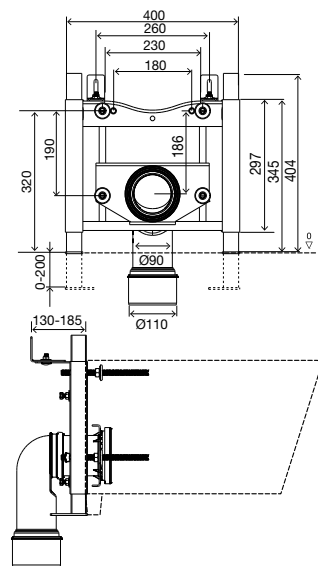

GENERAL FEATURES

- Compatible with wall-hung toilets;
- Solid wall or drywall installation;
- Frame tested for a 400kg load;
- Height adjustable from 0 to 200mm;
- Depth adjustable outlet bend.

INCLUDED

- Toilet fixing material;
- Frame fixing material;
- Outlet bend and Ø90/110 adaptor.

GENERAL FEATURES

- Compatible with wall-hung toilets;
- Drywall installation;
- Frame tested for a 400kg load;
- Height adjustable from 0 to 200mm;
- Depth adjustable outlet bend.

INCLUDED

- Toilet fixing material;
- Frame fixing material (floor);
- Outlet bend and Ø90/110 adaptor.

GENERAL FEATURES

- Compatible with all-hung toilets with 4 fixations;
- Axial seal;
- Drywall installation;
- Frame tested for a 400kg load;
- Height adjustable from 0 to 200mm;
- Depth adjustable outlet bend.

INCLUDED

- Toilet fixing material;
- Frame fixing material (floor);
- Outlet bend and Ø90/110 adaptor;
- Horizontal outlet pipe 250mm.

WC FRAME

Flush valve

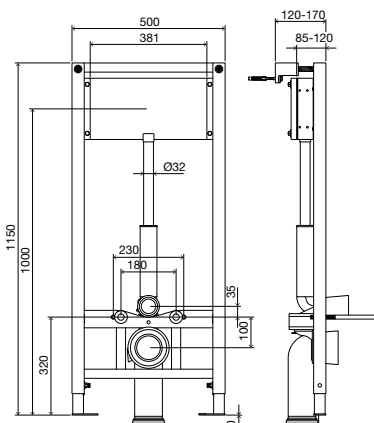

GENERAL FEATURES

- Compatible with wall-hung toilets;
- Solid wall or drywall installation;
- Easy and quick installation with Fast-Fit system;
- Frame tested with 400kg load;
- Height adjustable from 0 to 200mm;
- Adjustable mounting plate;
- Flush valve not included.

INCLUDED

- Toilet fixing material;
- Frame fixing material;
- Inlet and outlet toilet connection;
- Outlet bend and Ø90/110 adaptor.

URINAL

Sanitarblock

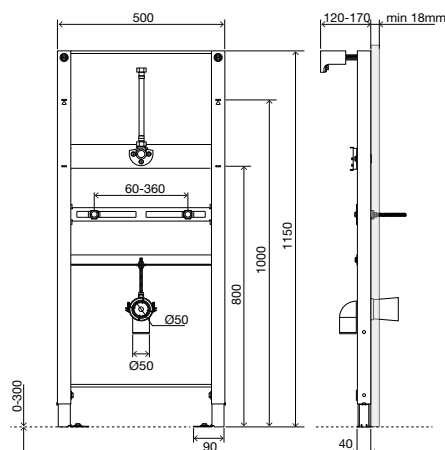

GENERAL FEATURES

- Frame for wall-hung urinals;
- Solid wall or drywall installation;
- Painted tubular frame;
- Easy and quick installation with Fast-Fit system;
- Frame tested for a 130kg load;
- Height adjustable from 0 to 200mm;
- Adjustable attachment plates;
- The flush valve has to be installed before closing the wall;
- One man assembly;
- 120mm thick.

INCLUDED

- Frame fixing material;
- Outlet bend Ø 50/50;
- G ½" fitting for tap connection (adjustable);
- ½" flexible hose.

ECO URINAL FRAME

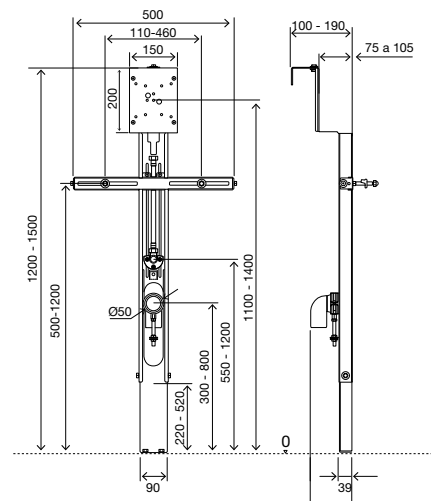

GENERAL FEATURES

- Frame for wall-hung urinals;
- Solid wall or drywall installation;
- Easy installation, compact and light;
- The flush valve has to be installed before closing the wall;
- Height adjustable from 0 to 300mm;
- 100mm thick

INCLUDED

- Frame fixing material;
- Outlet bend 50/50 (adjustable);
- G ½ fitting for tap connection (adjustable);
- ½ flexible hose.

URINAL DIVIDER

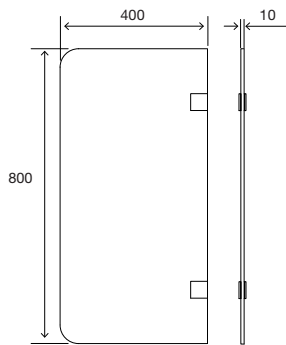

EASY STRUCTURE

Sanitarblock

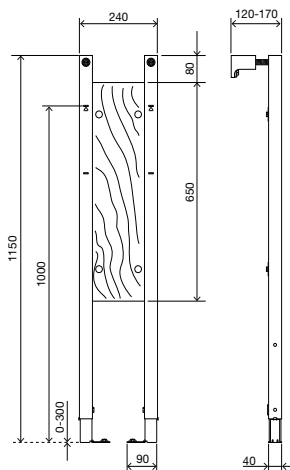

STOP FIRE

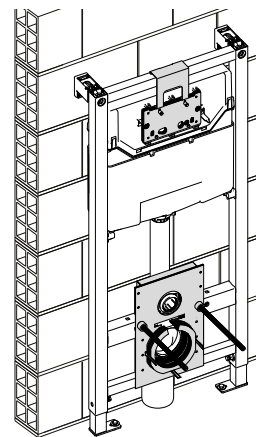

GENERAL FEATURES

- Frosted glass;
- Tempered Glass 8mm thick;
- Stainless steel fixing accessories;
- Fixation directly to the wall, drywall or solid wall;
- Compatible with Easy Structure.

INCLUDED

- Urinal divider fixing material.

GENERAL FEATURES

- Frame for wall-hung urinal dividers;
- Solid wall or drywall installation;
- Easy and quick installation with Fast-Fit system;
- Adjustable height from 0 to 200mm;
- Strengthened plywood;
- One man assembly.

INCLUDED

- Frame fixing material.

GENERAL FEATURES

- Application for flush plates and in wall cisterns;
- Steel and painted with polyester powder fitted with special intumescent inserts 27% mineral graphite and are rated B2 according to DIN 4102;
- Compliant with EN 13501-2:2'16;
- Compatible with: OLI74 PLUS, OLI120 PLUS, QUADRA PLUS and EXPERT PLUS*.

INCLUDED

- Fixation set for application.



ECO WC/BIDET

Simflex

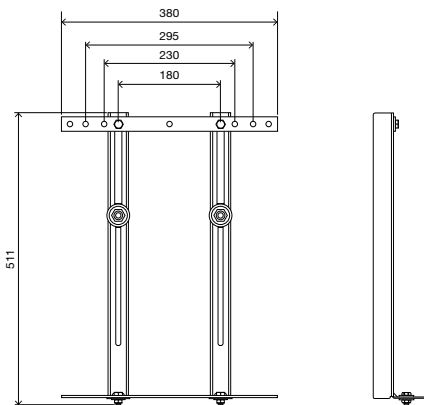

GENERAL FEATURES

- Frame for wall-hung toilet or bidet;
- Solid wall installation;
- Galvanized frame;
- Adjustable in width.

INCLUDED

- Toilet/Bidet fixing material;
- Frame fixing material.

BIDET

Simflex

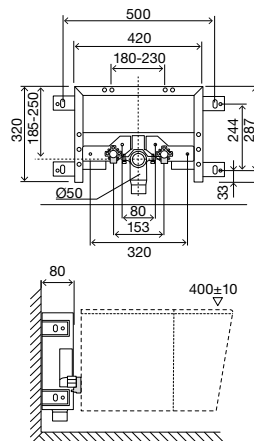

GENERAL FEATURES

- Frame for wall-hung toilet;
- Solid wall installation;
- Galvanized frame;
- Adjustable attachment plate;
- 80mm thick.

INCLUDED

- Bidet fixing material;
- Frame fixing material;
- Outlet bend and Ø40/32/50-40.

ECO BIDET

Sanitarblock

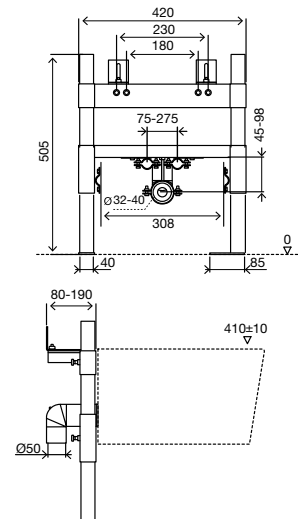

GENERAL FEATURES

- Frame for wall-hung bidet;
- Solid wall or drywall installation;
- Painted tubular frame;
- Frame tested for a 400kg load;
- Adjustable height;
- Adjustable attachment plates;
- 80mm thick.

INCLUDED

- Bidet fixing material;
- Frame fixing material;
- Outlet bend Ø 40 - 32/50 - 40.



BIDET

Sanitarblock

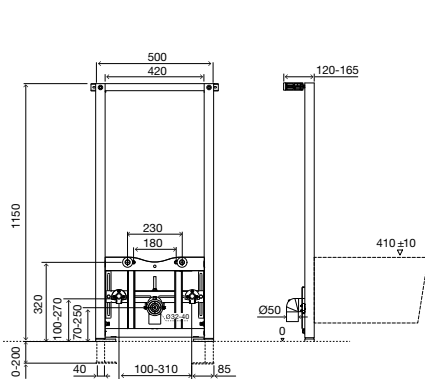

GENERAL FEATURES

- Frame for wall-hung bidet;
- Solid wall or drywall installation;
- Easy and quick installation with Fast-Fit system;
- Frame tested for 400kg;
- Height adjustable from 0 to 200mm;
- Adjustable mounting plates;
- 120mm thick.

INCLUDED

- Bidet fixing material;
- Frame fixing material;
- Outlet bend Ø40mm - 32 / 50mm - 40mm;
- Two G ½ fittings for water connection.

WASHBASIN

Simflex

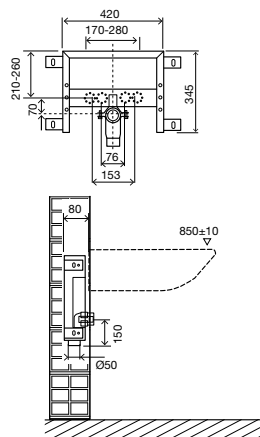
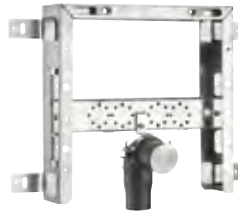

GENERAL FEATURES

- Frame for wall-hung washbasin;
- Solid wall installation;
- Galvanized frame;
- Adjustable attachment plate;
- 80 mm thick.

INCLUDED

- Fixing material;
- Outlet bend Ø 40-32/50-40.

WASHBASIN

Sanitarblock

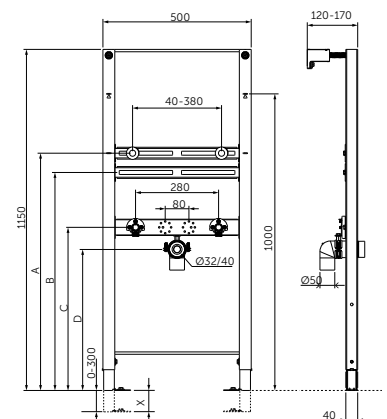

GENERAL FEATURES

- Frame for wall-hung washbasin;
- Solid or drywall installation;
- Easy and quick installation with Fast Fit system;
- Height adjustable from 0 to 300mm;
- Fully adjustable mounting plates;
- One man assembly;
- 120mm thick.

INCLUDED

- Washbasin fixing material;
- Frame fixing material;
- Outlet bend Ø40mm - 32 / 50mm - 40mm;
- Two G ½ fittings for water connection.

CONCEALED SIPHON

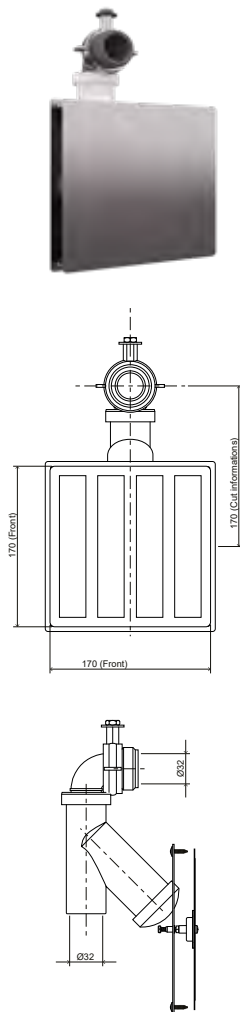

GENERAL FEATURES

- Concealed siphon for wall-hung washbasin;
- Hidden connections $\text{Ø}32$;
- Concealed siphon guarantees the maintenance access through imans;
- Possibility to customize the stainless steel cover plate.

INCLUDED

- Stainless steel plate 170x170mm;
- Outlet bend $\text{Ø} 32/32$;
- 2 suction cup;
- 4 glue strips.

SHOWER FRAME

Sanitarblock

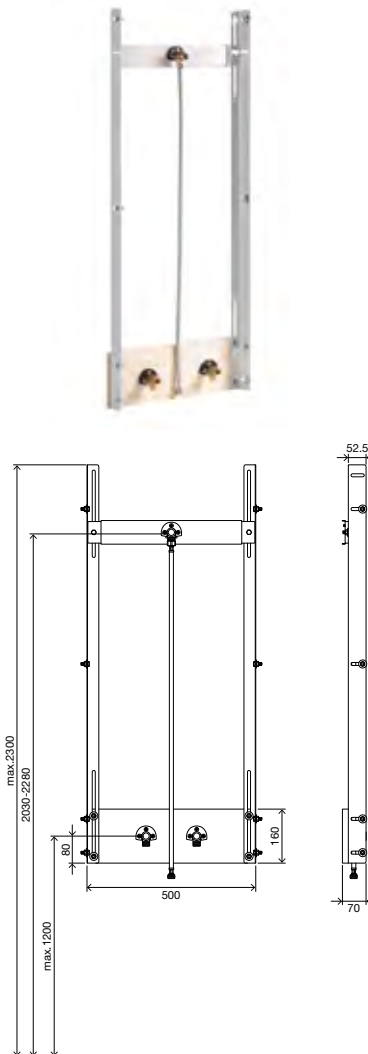

GENERAL FEATURES

- Frame for shower and taps;
- Solid wall or drywall installation;
- 70mm thick;
- Height adjustable;
- Adjustable attachment plate.

INCLUDED

- 3 water connections F/M $\frac{1}{2}$ "x $\frac{1}{2}$ " with seal and screws;
- Flexible tube F/Mx $\frac{1}{2}$ ";
- Frame fixing material.

ACCESSORIES



BYPASS CONNECTOR

- Connector between the outlet pipe and the outlet bend;
- The flushing can be tested before toilet installed.

CODE	DESCRIPTION
885233	Bypass connector



WC OUTLET BEND

- WC outlet bend for wall-hung toilets;
- L:340mm;
- Exit Ø90;
- Toilet connection Ø90.

CODE	DESCRIPTION
036888	PP wc outlet bend



WC OUTLET BEND

- WC outlet bend for wall-hung toilets;
- L:300mm;
- Exit Ø110;
- Toilet connection Ø90.

CODE	DESCRIPTION
622002	HDPE wc outlet bend 110



ECCENTRIC SET CONNECTION 25MM

- Accessory sets to enable the correction of incorrect applications;
- Toilet connection Ø90;
- Connection WC pipe Ø45x180.

CODE	DESCRIPTION
885108	Eccentric set connection 25mm



LONGER SLEEVES FOR WALL HUNG TOILETS

- Outlet pipe Ø90xØ125x300;
- Rubber seal for outlet pipe Ø125;
- Connection WC pipe Ø45x280;
- Rubber seal for WC pipe Ø45;
- M12x300 rods for wall-hung toilets fixation;
- Counter plate fixation screws;
- Toilet fixing material.

CODE	DESCRIPTION
011229	Longer sleeves for wall-hung toilets



FLEXIBLE OUTLET WC

- Flexible connection;
- L: Min 220mm/ Max 570mm;
- Exit Ø90/110;
- Toilet connection Ø80/100.

CODE	DESCRIPTION
079929	Flexible outlet wc bend



HORIZONTAL OUTLET WC

- L:300mm;
- Exit Ø110;
- Toilet connection Ø90.

CODE	DESCRIPTION
108380	Horizontal outlet wc



ACCOUSTIC INSULATION FOR WALL HUNG TOILET AND BIDET

- Accoustic insulation in expanded polyethylene;
- Avoids direct contact between the sanitaryware and the tile.

CODE	DESCRIPTION
620071	Accoustic insulation



PP OUTLET BEND ADAPTOR

- Connection Ø90/110

CODE	DESCRIPTION
086360	PP adaptor Ø90/110



DOUBLE OUTLET BEND

- Double outlet bend for wall-hung toilets with horizontal installation.

CODE	DESCRIPTION
622022	Double HPDE WC outlet bend D1 - Ø90, D2 - Ø110



STOP FIRE

- Application for flush plates and in-wall cisterns

CODE	DESCRIPTION
879808	Stop Fire



WALL TAP/CONCEALED FLUSH VALVE

- Compatible with all taps and urinal;
- Concealed flush;
- Adjustable mounting wood panel; Fixing material.

CODE	DESCRIPTION
881858	Wall tap or concealed urinal flush valve











ACCOUSTIC INSULATION

- 2 protections set for sanitarblock frames.

CODE	DESCRIPTION
167288	Foot accoustic insulation







PART NUMBER GUIDE

	WC	BIDET	WASHBASIN	URINAL
WC Sanitarblock 	714001	-	-	-
WC Free-standing 	616042	-	-	-
WC 4 fixations 	879027	-	-	-
WC frame 	880462	-	-	-
Urinal Sanitarblock 	-	-	-	136179
Eco Urinal 	-	-	-	879116
Urinal divider 	-	-	-	000079
Easy frame structure 	-	-	-	032714

WxDxH	Weight	Qt.	Multiple Box Dim	Weight	Qty per Pallet	Pallet Height	Pallet Width	Pallet Length	Weight
625x172x450	7.5	-	-	-	54	2.86	0.8	1.25	430.39
535x211x540	10.8	-	-	-	28	2.32	0.8	1.2	325.36
535x211x540	10.66	-	-	-	28	2.32	0.8	1.2	334.04
1180x140x530	12.14	-	-	-	20	2.35	0.8	1.2	288.8
1175x96x550	9.41	-	-	-	32	2.52	0.8	1.2	375.04
800x170x100	4.49	-	-	-	56	0.96	0.8	1.2	273.28
800x50x400	7	1	-	-	-	-	-	-	-
1170x65x260	6.38	-	-	-	48	1.37	0.8	1.2	389.76



PART NUMBER GUIDE

	WC	BIDET	WASHBASIN	URINAL
Eco Wc/Bide 		883176	-	-
Bidet 	-	006987	-	-
Eco bidet 	-	008908	-	-
Bidet Sanitarblock 	-	136078	-	-
Washbasin Simflex 	-	-	611011	-
Washbasin Sanitarblock 	-	-	881857	-
Shower frame 	880461	-	-	-

WxDxH	Weight	Qt.	Multiple Box Dim	Weight	Qty per Pallet	Pallet Height	Pallet Width	Pallet Length	Weight
547x151x60	1.98	-	-	-	110	0.78	0.8	1.2	234.16
441x333x97	4.2	-	-	-	100	1.71	0.8	1.2	448
513x126x180	6.92	-	-	-	120	1.78	0.8	1.2	136.8
1175x96x550	11.24	-	-	-	24	1.81	0.8	1.2	293.76
441x333x97	4.2	-	-	-	100	1.71	0.8	1.2	448
1175x96x550	8.71	-	-	-	32	2.52	0.8	1.2	293.12
1200x65x260	4.36	-	-	-	48	1.37	0.8	1.2	281.28

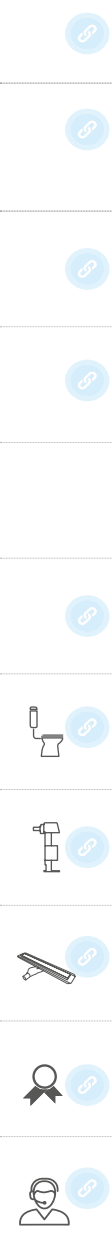

FLUSH PLATES



878784
TRUMPET Bronze/Copper





The wide range of OLI flush plates are characterized by their versatility and durability. Designed with cutting edge technology they are suitable for all bathrooms, whether they be public bathrooms or private bathrooms.

OLI has the perfect flush plate for any situation. From infrared sensors that allow flushing without having to touch the flush plate to models that are highly resistant and vandal proof for public bathrooms.

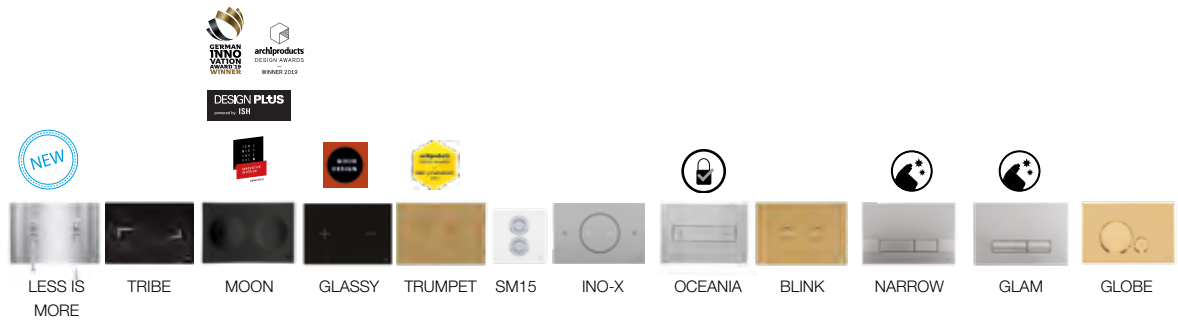

COMPATIBILITY MATRIX



Product	LESS IS MORE	TRIBE	MOON	GLASSY	TRUMPET	SM15	INO-X	OCEANIA	BLINK	NARROW	GLAM	GLOBE
 OLI120 PLUS	(M) Minimum 10mm	(NT) Minimum 10mm	(NT) Minimum 10mm	(NT) Minimum 10mm	(P) Minimum 10mm	(P) Minimum 25mm		(P) Minimum 35mm	(P) Minimum 10mm	(M) Minimum with OLIPURE 25mm Minimum no OLIPURE 20mm	(M) Minimum with OLIPURE 25mm Minimum no OLIPURE 20mm	(M) Minimum 15mm
 OLI74 PLUS	(M) Minimum 5mm	(NT) Minimum 10mm	(NT) Minimum 10mm	(NT) Minimum 10mm	(P) Minimum 10mm	(P) Minimum 10mm	(M) Minimum 10mm	(P) Minimum 25mm	(P) Minimum 10mm	(M) Minimum with OLIPURE 5mm Minimum no OLIPURE 5mm	(M) Minimum with OLIPURE 5mm Minimum no OLIPURE 5mm	(M) Minimum 5mm
 OLI80												
 EXPERT PLUS Possible lower position	(M) Minimum 5mm				(P) Minimum 10mm	(P) Minimum 10mm		(P) Minimum front application 0mm Minimum top application 30mm	(P) Minimum 10mm	(M)* Minimum with OLIPURE 5mm Minimum no OLIPURE 5mm	(M)* Minimum with OLIPURE 5mm Minimum no OLIPURE 5mm	(M)* Minimum 5mm
 QUADRA PLUS	(M) Minimum 15mm				(P) Minimum 10mm	(P) Minimum 10mm	(M) Minimum 15mm	(M) Minimum 15mm	(P) Minimum 10mm	(M) Minimum 10mm	(M) Minimum 10mm	(M) Minimum 10mm

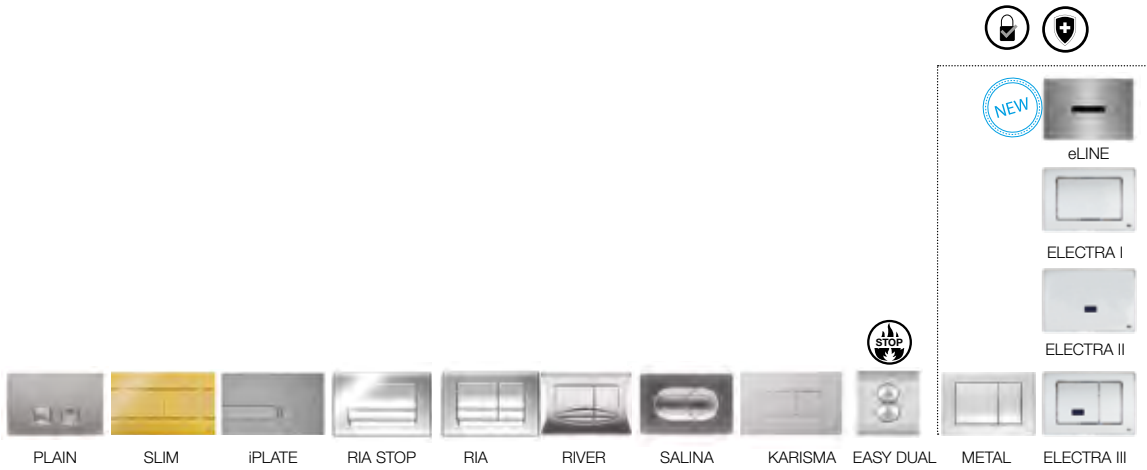

some versions compliant with

(M) Minimum 15mm
 (M) Minimum 15mm
 (M) Minimum 15mm
 (M) Minimum 10mm
 (M) Minimum 10mm
 (P) Minimum 20mm
 (P) Minimum 20mm
 (P)
 (M)
 (E)



(M)
 (M)
 (M)
 (M)
 (M)
 (M)
 (P) Minimum 25mm
 (P) Minimum 25mm
 (P)
 (M)
 (E)



(M)
 (M)
 (M)
 (M)
 (M)
 (M)
 (M)
 (M)













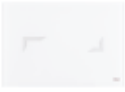

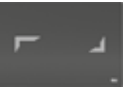





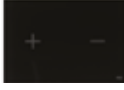
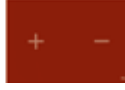
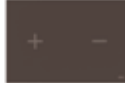

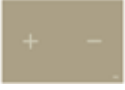









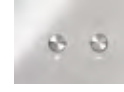

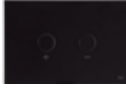



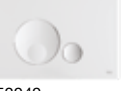



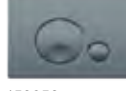





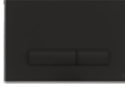



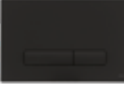

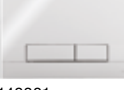

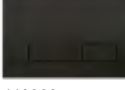

(M)* Minimum 5mm
 (M)
 (M)
 (M)
 (M)
 (M)
 (P) Minimum front application 0mm
Minimum Top application 30mm
 (P) Minimum front application 0mm
Minimum Top application 30mm
 (P)
 (M)

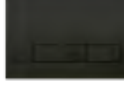

(M) Minimum 10mm
 (M) Minimum 15mm
 (M) Minimum 10mm
 (M) Minimum 5mm
 (M) Minimum 5mm
 (M) Minimum 5mm
 (P) Minimum 15mm
 (P) Minimum 15mm
 (P)
 (M)



FLUSH PLATES

TRIBE  879065 White □						 879063 Black ■	 879066 Red ▸	 879068 Anthracite □	 879067 Gold ■	 879071 Taupe ✕	MOON  878848 White □		 878981 Black ■						
GLASSY  878849 White □						 878850 Black ■	 878703 Red ▸	 878702 Anthracite □	 878700 Gold ■	 878701 Taupe ✕	SM15  022238 White tempered glass □								
INO-X 02  660002 Polished chrome □		 661002 Brushed □		INO-X 06  660006 Polished chrome □		 661006 Brushed □		LESS IS MORE NEW  883526 White □				 883524 Polished chrome □	 883525 Brushed □	 883527 Black ■					
BLINK								NEW				 216621 White □	 154963 Polished chrome □	 093399 Brushed □	 882567 Gun Metal □	 878489 Black ■	 878781 White gold ■	 883246 Gold plated ■	 878782 Bronze/Copper ■
GLOBE  152949 White □						 152950 Polished chrome □	 152951 Matt chrome □	 152952 Black soft-touch ■	 152953 Grey soft-touch □	 152954 Gold plated ■	BLINK II NEW  884967 Brushed □								
GLAM  139178 White OLIpure □								 139179 Polished chrome OLIpure □	 139180 Matt chrome OLIpure □	 139181 Black soft-touch OLIpure ■	 139184 White □	 139185 Polished chrome □	 139186 Matt chrome □	 139187 Black soft-touch ■					
NARROW  148300 White OLIpure □								 148301 Polished chrome OLIpure □	 148302 Matt chrome OLIpure □	 148303 Black soft-touch OLIpure ■	 152939 White □	 152940 Polished chrome □	 152941 Matt chrome □	 152942 Black soft-touch ■					
SALINA  640081 White □				 640084 Polished chrome □	 640086 Matt chrome □	 640097 Black soft-touch - Polished chrome button ■ + □	RIVER  638501 White □				 638504 Polished chrome □	 638506 Matt chrome □	 638508 Gold plated ■						

OCEANIA

054564 Mech stainless steel - Brushed ☐	054554 Mech glass White ☐	054557 Mech glass Black ●	054562 Mech stainless steel button - glass Black ■ + ☐	054558 Mech stainless steel button - glass White ☐ + ☐	054561 Mech stainless steel - Polished chrome ☐	882412 Mech stainless steel - white gold ●
054988 Pneu stainless steel - Brushed ☐	054989 Pneu glass White ☐	054992 Pneu glass Black ●	054996 Pneu stainless steel button - glass Black ■ + ☐	054993 Pneu stainless steel button - glass White ☐ + ☐	054998 Pneu stainless steel - Polished chrome ☐	

OCEANIA MIA

054563 MIA mech (customizable) ☐
054997 MIA pneu (customizable) ☐

RIA

640591 White bacter proof ☐	640584 Polished chrome ☐	640586 Matt chrome ☐

PLAIN

070826 White ☐	070827 Polished chrome ☐	070828 Matt chrome ☐	070829 Black soft-touch ●

RIA START -STOP

010234 White ☐	010244 Polished chrome ☐

KARISMA

641001 White ☐	641004 Polished chrome ☐	641006 Matt chrome ☐	641015 Black soft-touch ●

SLIM

659041 White ☐	659044 Polished chrome ☐	659046 Matt chrome ☐	659055 Black soft-touch ●	010216 Grey soft-touch ☐	154962 Gold plated ●	057141 Inox ☐

IPLATE

670001 White ☐	670004 Polished chrome ☐	670006 Matt chrome ☐	670005 Black soft-touch ●

METAL

CG18000011418 Polished chrome ☐	CG18000011419 Matt chrome ☐

EASY DUAL

011640 White ☐	011642 Chrome ☐

ELECTRA III

079206 Polished chrome zamac ☐

ELECTRA II

079205 Polished chrome zamac ☐

ELECTRA I

079207 Polished chrome zamac ☐

eLINE NEW

880876 Brushed ☐

TRUMPET

046199 Polished chrome ☐	046198 Brushed ☐	878783 White gold ●	883245 Gold plated ●	878784 Bronze/Copper ●

eAQUA urinal

879120 Brushed Stainless steel AC ☐
879119 Brushed Stainless steel BATT ☐

BLINK urinal

882264 Polished chrome zamac ☐

SM15 URINAL

034265 White tempered glass ☐

GLOBE URINAL

878466 White ☐	878818 Polished chrome ☐	878819 Matt chrome ☐	878822 Gold plated ●



879063
TRIBE Black

FLUSH PLATES

OLI flush plates take centre stage in any bathroom.



NO- TOUCH

No-Touch flush plates activates the flush through the proximity of a hand towards the flush plate. When sensor detects the hand it activates the desired flush.



PNEUMATIC

The pneumatic version is expressed by a smoothly actuation of flushes being selected by Siza Vieira Architect to design Trumpet flush plate.



MECHANIC

In every flushes, it is sense the high-quality button mechanics of the OLI's flush plates. This mechanic actuations are part of several flush plates with a panoply of finishes and materials.

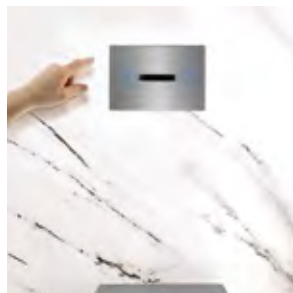

ELETRONIC

The flush plates with infrared sensors, detect the user and, in an automatic behaviour, they flush as soon as the user retires from the space, avoiding the need to touch the flush plates.

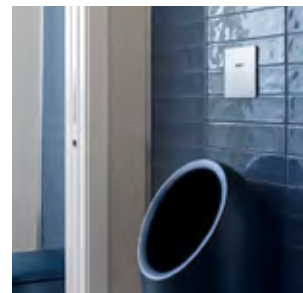

URINAL

A varied range of flush plates for urinals for public bathrooms or private bathrooms are developed by high standards of OLI.





FLUSHES DETAIL

An essential form, with two cords, whose purpose is unequivocal, projecting out from semi circular reels mounted on a metal base. The plate has no buttons, because we wanted to take a step forward. Without removing anything, without adding anything. Just looking with new eyes at the elements in play. Without the buttons, the object sheds its old skin and reaches out towards the user.



Design

Alessio Pinto architect designed this amazing flush plate. Born in Rome on the 12th of July 1968, Alessio Pinto architect states:
"At a glance we realise the meaning of Plus and Minus. All it takes is viewing the cords as analog signs".
 Alessio Pinto



Black



White



Brushed

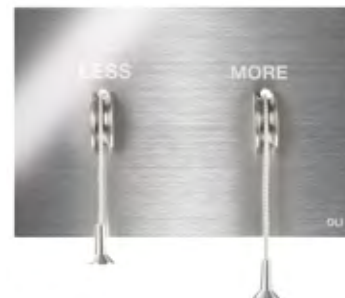

Matt chrome

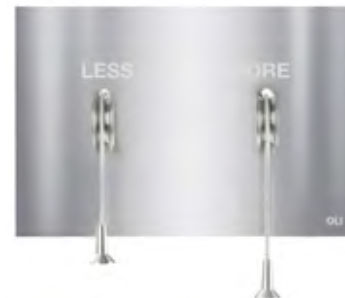

LESS IS MORE



Is the name of this flush plate, whose design was inspired by the history of the mechanism and a desire to give it an innovative form and launch it into the future.

Plus and Minus, no more, no less. There are no signs or symbols to decipher. Only a choice to be made, with one look. A subtising of the action.

Design is a reflection of the time, as it finds expression through continually changing, and yet simple and essential, gestalts, complete in the meanings they must convey without vain decorative frills.



"I am very pleased with the prestigious "Best of Category 2016" award for the Trumpet flush plate. The quality achieved is due to the competent and committed contribution of the technicians at OLI. It was a pleasure to evolve the design of the flush plate with them."

Álvaro Siza





Design



Álvaro Siza Vieira

Álvaro Siza Vieira is a world-renowned architect who has collected several international awards, Pritzker Prize in 1992; The Wolf Prize of Arts in 2001; the Golden Lion for Lifetime Achievement in 2012; the Fritz Hoger award in 2014, just to name a few.

The Trumpet flush plate was designed by Álvaro Siza Vieira and is the perfect combination of elegance and harmony, both characteristics of a trumpet. In 2016, the Trumpet was selected Best of Category for the Archiproducts Design Awards one of the most prestigious awards of Architecture and Design worldwide.



TRUMPET

This unique piece was inspired by jazz to create a flush plate with two buttons similar to the pistons of a trumpet, thus bringing the virtuosity of music to the bathroom space. OLI believes that this distinction recognizes the uniqueness of the Trumpet flush plate.





SM15

SM15 is a tempered white glass flush plate, 147mm by 147mm, and is ideal for a smooth application on walls covered with traditional Portuguese tiles. The SM15 is installed surface-even with the wall for a seamless and elegant look.

Compatibility

Matching urinal flush plate also available.
(See page 194 for more information)





Design

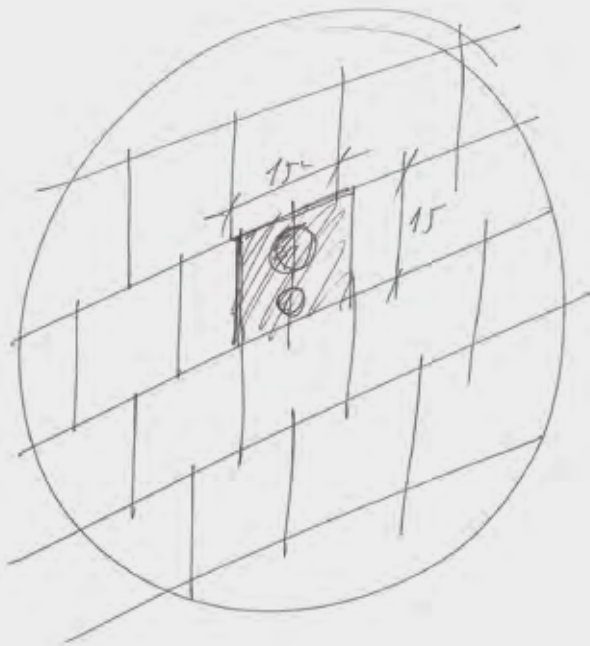

Souto de Moura



Projects



PORTUGAL POUSADA, COVILHÃ, PORTUGAL

In 2001, in collaboration with OLI, Souto de Moura developed the SM15 for the new Pousada de Portugal in Covilhã, with bathroom walls covered with traditional Portuguese tiles.

Souto de Moura

Souto de Moura is a renowned Portuguese architect who has been presented with various international awards, such as, the Gold Medal of Heinrich Tessenow Foundation in 2001; the Pritzker Award in 2011; the Wolf Prize of Arts in 2013; just to name a few.

In 2001, in collaboration with OLI, Souto de Moura developed the SM15 for the new Pousada de Portugal in Covilhã.



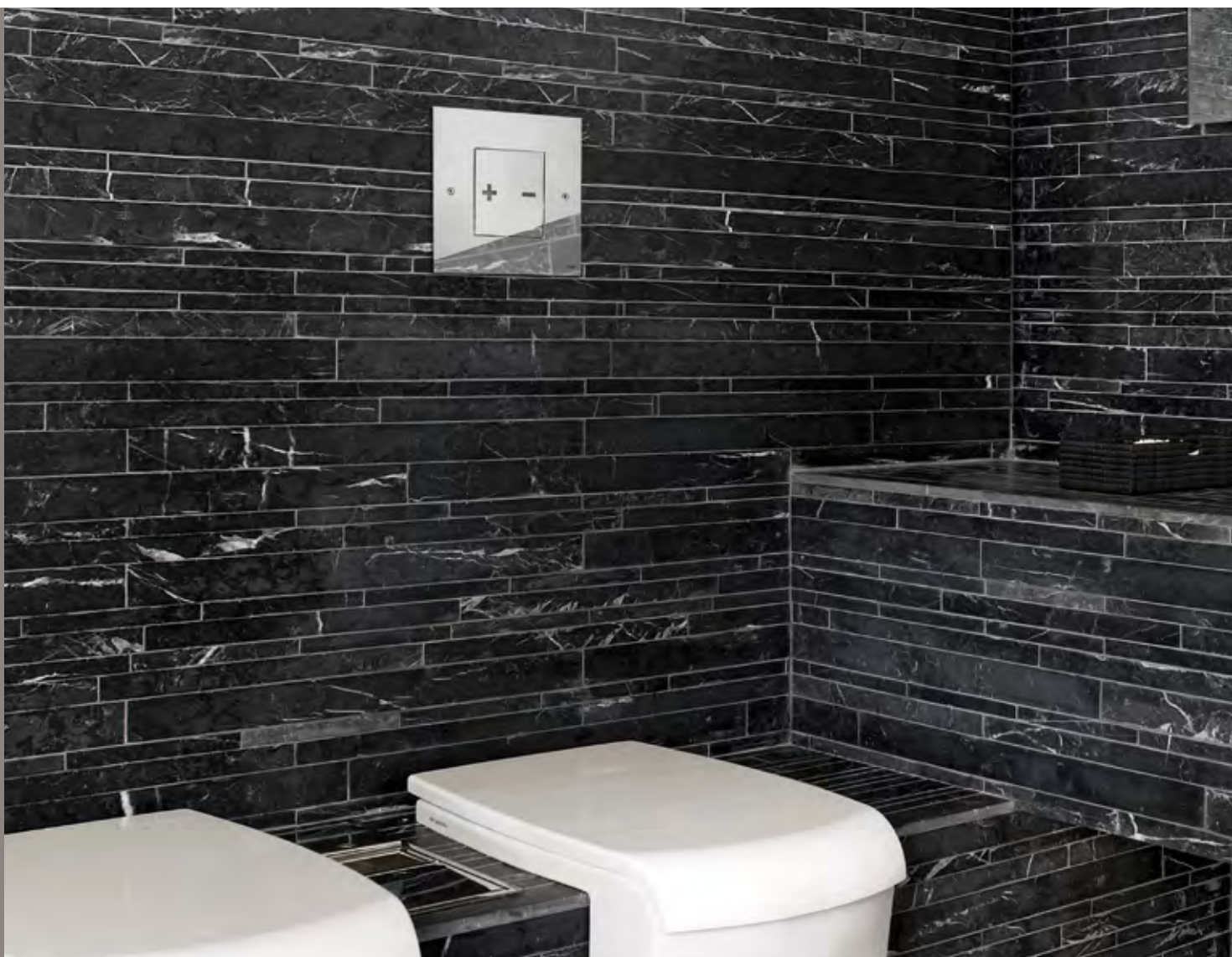

INO-X

The Ino-x line is a collaboration with the Italian architect Romano Adolini, an influential figure in bathroom design. The result is a high quality and robust flush plate. This philosophy has generated a collection of models with essential lines, using only squares, rectangles and circles.



Design



Ino-x 02

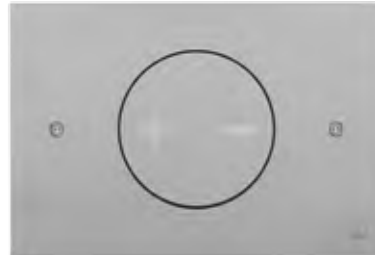

Ino-x 06



Romano Adolini

The Ino-x flush plate collection was designed by Romano Adolini, an Italian architect and designer who is an influential figure in bathroom design.

The Ino-x collection is simple, elegant and with a strong visual impact:

"A simple sheet of steel that is only 2mm thick cut with a precise laser".

Romano Adolini



878848
MOON White



Design



VISTA ALEGRE
1924

MOON

A ceramic piece that is aesthetically pleasing with easily distinguished shapes.

This notable flush plate combines high technology with tradition, resulting in a smooth and comfortable interface for the user, whose elegance of shapes highlights the dual flush and favours the half flush.



Hydroboost

No-Touch actuation

The use of capacitive sensors enabled OLI to develop the concept around a one-piece ceramic plate with innovative formal and tactile features that ensure superior hygiene levels and ergonomics.



AC power-mains

- Innovative concept with capacitive sensors;
- Easy installation;
- Plug and Play.



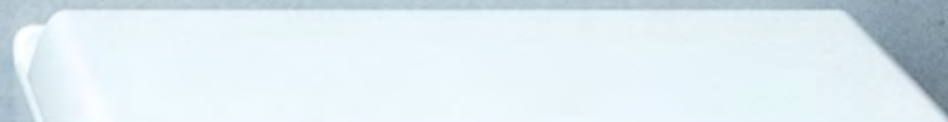

GLASSY

Glassy increases the hygiene and safety levels thanks to the No-Touch system. The approach of the hand to the flush plate is sufficient for the capacitive sensors to trigger the flush. Glassy is a unique piece in glass, with minimalist design, available in six finishes.



Design

Hydroboost

No-Touch actuation

The use of capacitive sensors enabled OLI to develop the concept around a one-piece ceramic plate with innovative formal and tactile features that ensure superior hygiene levels and ergonomics.



AC power-mains

- Innovative concept with capacitive sensors
- Easy installation
- Plug and Play

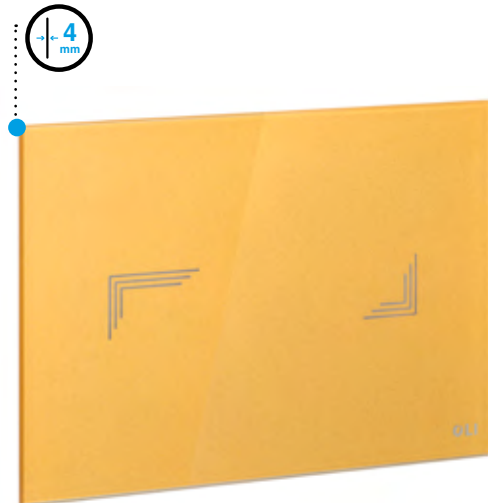

TRIBE

Green is a Trend
Sustainability is a Mindset

Features a new and improved capacitive sensor with enhanced capabilities. OLI's newest flush plate presents itself with two distinct power options.





OCEANIA

With the Oceania flush plate, OLI has achieved the goal of combining simple aesthetic design with elegantly unique features.



Projects



GLASS AND STEEL

Glass and steel perfectly combined. This are precious materials with a lustrous shine that conveys elegance and style to bathrooms.



VANDAL RESISTANT

Oceania includes a vandal resistant lock and is perfect for installation in public bathrooms.

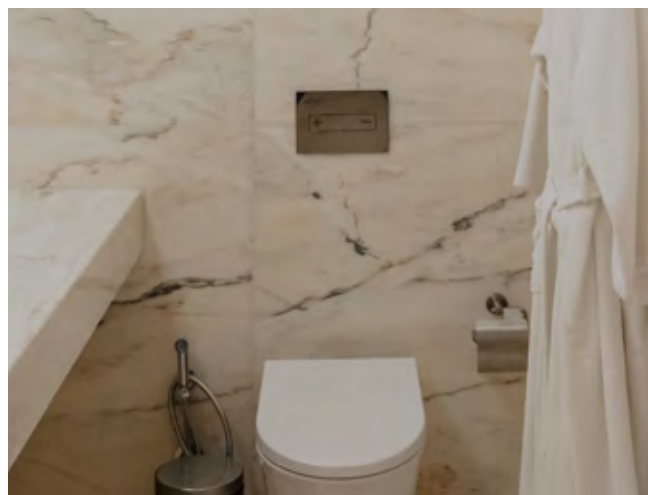

HOTEL PAÇO DE VITORINO, PONTE DE LIMA, PORTUGAL

The rehabilitation of Paço de Vitorino, was born from the appreciation of the inherited patrimony. all rooms of this hotel, inaugurated in 2018, are equip with Oceania flush plate.

"Flush plates proposals that distinguish for its manufacturing quality, sober and careful drawing and easiness of use".

MIA

The Oceania Mia allows to choose the finishes (wood, marble, ceramic, etc.) and using the supplied tools, personalize a unique flush plate.



MECHANIC

In every flushes, it is sense the high-quality button mechanics of the OLI's flush plates. This mechanic actuations are part of several flush plates with a panoply of finishes and materials.



PNEUMATIC

The pneumatic version is expressed by a smoothly actuation of flushes.

An infinite world of custom-made finishings



Customize Oceania with preferred finishing with any 10-mm-thick material. The Oceania Mia flush plate is provided with a high-resistance dual-adhesive glue for easy application of any front finishing in bathroom.

For the finishing of flush plate to be perfect, this version is provided with a stainless steel frame and matt chrome push button.





878489
BLINK Black

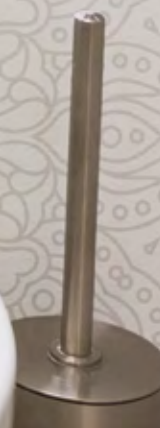



BLINK II

Reliability in public spaces it is something extremely important. For that, OLI launch Blink II to deliver this characteristic as a vandal-proof solution. A stainless steel fluxometer solution that perfectly integrates safe in the public bathrooms of stadiums, theaters, concert halls.

Matching urinal flush plate also available.
(See page 195 for more information)



WC Frame and Toilet concealed pre-installation is needed for wall-hung toilets. See page 137.



Kit floor mounted toilet and Toilet concealed pre-installation is needed for floor mounted toilets. See page 143.



BLINK

A stainless steel flush plate that perfectly reflects the contemporary lifestyle and transforms bathroom into a stylish space. Blink is a unique and versatile flush plate that integrates into any style of decor.





INSPECTION PLATE

Compatible with all pneumatic systems (OLI74 Plus, OLI120 Plus and Expert Plus), this solution presents a reduce thickness (0,5mm) and a high resistance, as it is made in stainless steel.



SEAMLESS

Inspection plate for in-wall cisterns differentiates itself from all competition, by allowing the coverage of the inspection plate with the bathroom coating finishing.

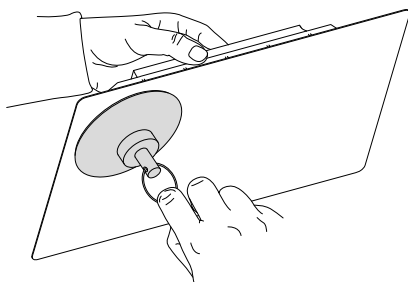



KINDERGARDEN BABILOU, BRUSSELS, BELGIUM

This charming house is a kindergarden in Belgium. Completely renovated with all the comforts, easy access and a beautiful private garden at the back of the building, this amazing place choose Shpera flush plate and Expert Plus in-wall cistern, to equip their bathrooms.

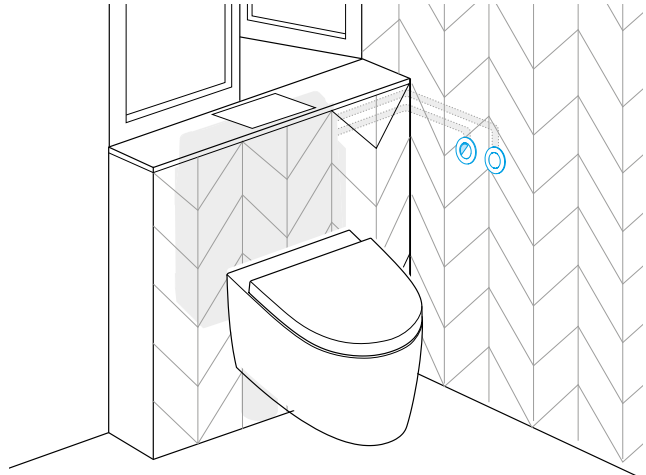

The main advantage of this solution, is that you can apply the flush buttons in any place at a maximum distance of 2.5 meters from the cistern.



SPHERA*

Single flush pneumatic actuator that is compatible with all OLI pneumatic in-wall cisterns. For solid wall installations only.



PNEUMATIC ACTUATOR*

Single flush pneumatic actuator that is compatible with all OLI pneumatic concealed and exposed cisterns. This range have solution for installing in-wall or outside the wall. Peumatic actuator fits in bathrooms with drywall.



MINI TREND

The brightness of the steel reflects the careful choice of details. Trend fits discreetly in any trendy bathroom.



MONO TREND

Pneumatic flush plate that allows free positioning of the flush plate compared to traditional solutions. For those who make minimalism a matter of style.





Projects



APPLE BUILDING, TEL AVIV, ISRAEL

OLI has equipped the Apple building, located north of the city of Tel Aviv, which houses the second largest Center for Research and Development in the world for the North American brand. Karisma flush plate and OLI80 Sanitarblock pneumatic in-wall cistern were selected for the bathrooms.



KARISMA

The choice with character. Rigorous design meets the softness of the soft-touch finish. Karisma will distinguish bathroom from all others.

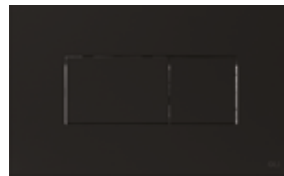
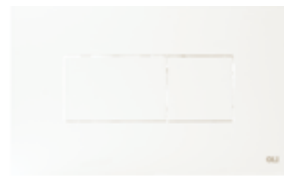



SALINA

The link between traditional and modern. The soft and minimalist design, its small size, the mono or two-colour finish, the elegance of the soft touch combined with the intensity of the chrome or the simplicity of white.

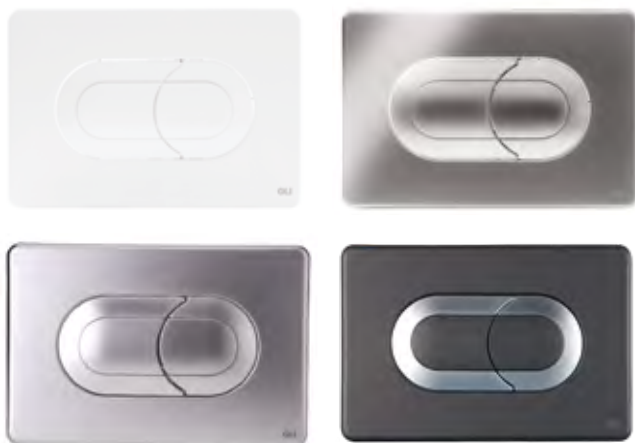

Projects



EDIFICIO VILLANOVA BUSINESS CENTER, BOGOTÁ, COLOMBIA

OLI was chosen to equip the bathrooms in the VILLANOVA BUSINESS CENTER, an office building in Colombia. The building was equipped with the Salina flush plates.





640591
RIA White bacterial proof

IT IS COMMON KNOWLEDGE THAT WHEN FLUSHES THE TOILET A TOILET PLUME IS RELEASED INTO THE AIR TRANSPORTING BACTERIAS.

Developed new products to face the spread of bacterias in bathrooms, turns out to be a goal for OLI who strives to find an antibacterial solution for flush plates.



RIA

OLI has a model that responds to the concern of protecting any environment against the spread of bacteria, especially when thinking about bathrooms in hospitals, senior homes or any other public space.

BATHROOMS WITH ANTIBACTERIAL SURFACES

There are lots of bacterias that could be found in a toilet plume include E. coli, Salmonella, and Staphylococcus aureus. All of which could cause symptoms such as diarrhoea and stomach cramps. OLI rethink and developed a version of flush plates that responds to the concern of protecting any bathroom against the spread of bacteria.

HIGH PERFORMANCE STAGES

Tests performed and supervised according to the standard ISO 22196, were conducted by a german laboratory QualityLabs BT, includes in OLI's range a finish version. This development responds to the concern of protecting any environment against the spread of bacteria, especially when thinking about bathrooms in hospitals, senior homes or any other public space.



"ABS raw material + treatment showed sufficient antimicrobial activity (>99.99%)", according to german laboratory QualityLabs BT.



OLIpure®



GLAM

Making the ordinary glamorous. Glam fits in with any bathroom décor without blending into the background. Glam is meant to stand out and be glamorous. This range has a white version whose final finish is antibacterial since its coating inhibits the growth of microorganisms such as bacteria, fungi or algae.



OLI^{pure}®

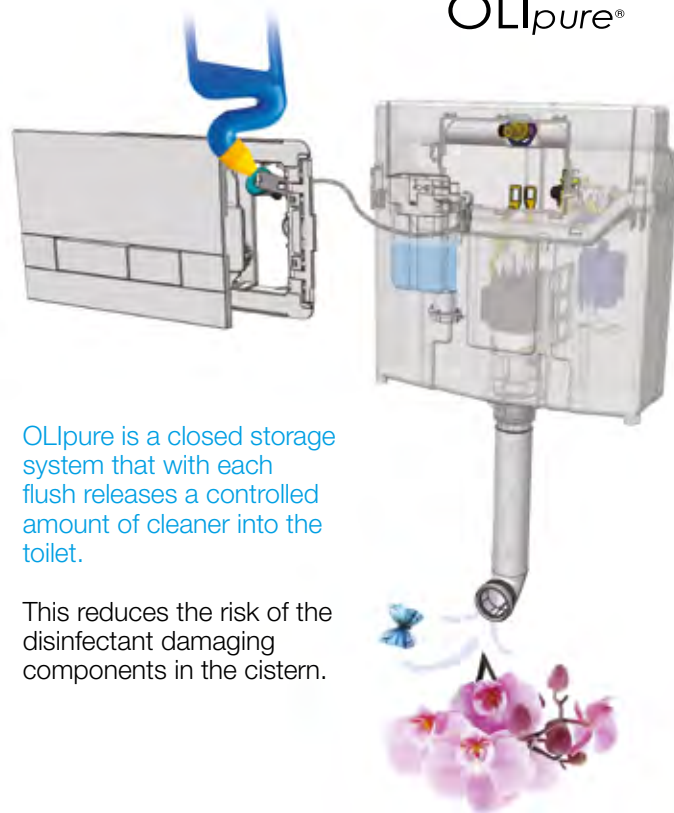

OLI^{pure} is a closed storage system that with each flush releases a controlled amount of cleaner into the toilet.

This reduces the risk of the disinfectant damaging components in the cistern.



SAFE AND INNOVATIVE SYSTEM
Doesn't contaminate the water or any component inside the cistern closed system;



USER FRIENDLY
Easy and quick refill.



CONTROLLED DOSING
Releases only 2ml per flush long lasting.



AMBIWAVE*
450ml dosage.

OLI^{pure}®



NARROW

Strikingly beautiful. Narrow is designed with a strikingly linear elegance that brings class and beauty to any bathroom. This range has a white version whose final finish has a treatment used releases metal ions on its surface and these interfere with the metabolism of microorganisms to stop their proliferation and eliminate them.





GLOBE

Well-rounded and classic. Globe easily distinguishes between the full flush and the half flush and provides a circular consistency with the surrounding bathroom décor. Globe has a white version with treatment in raw material to responds the concern of protecting any bathroom against the spread of bacteria.



Projects



YUKO BUILDING, MADRID, SPAIN

YUKO is one of the most exclusive buildings in Madrid. Located in a block near the Paseo da Castellana, one of the main avenues in the spanish capital, this project has the stamp of Allende Architects (Madrid and Lima). To attend the design, sustainability and well being goals, the flush plate Globe Matt and OLI120 Plus Sanitarblock hydraulically sustainable where chosen for the project.

Matching urinal control plate also available.
(See page 194 for more information)





IPLATE

An ABS flush plate for in-wall cisterns that allows to mix and match colours of the buttons.

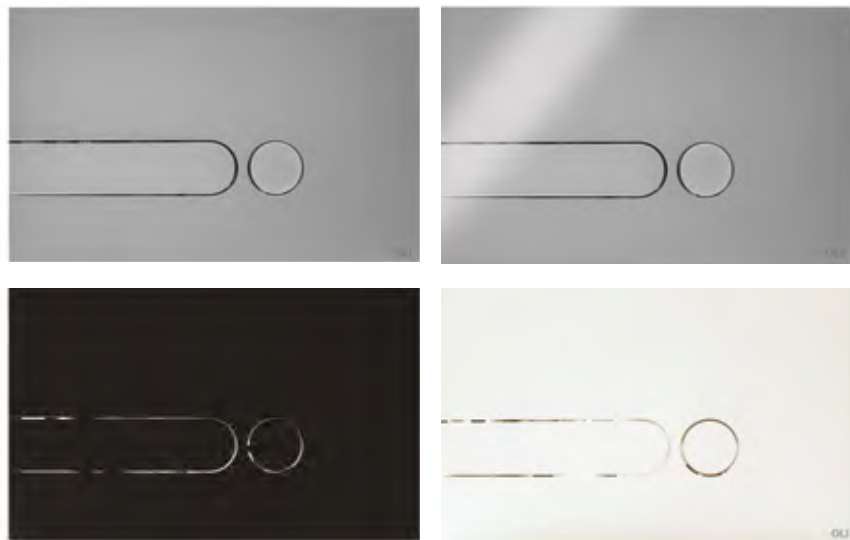

KITS

Possibility of replacing the flush buttons with kit elegance and kit fantasy. See page 214.





10216
SLIM Grey soft-touch



SLIM INOX

A stainless steel flush plate. Perfect symmetry of form, slim and classy, with braille inscriptions.



Projects



CRUISE TERMINAL, LISBON

The new Cruise Terminal in Lisbon, on the Tobacco Garden in Santa Apolonia, selected OLI solutions for their bathrooms. These spaces were equipped with Slim Inox and OLI74 Plus cistern.



SLIM

The Original. Perfect symmetry and elegance of form, slim and classy, with braille inscriptions.



Projects



AMAZON DISCOVERY BOAT HOTEL PERU

It is a unique hotel project that offers contact with the natural beauty of the Amazon jungle. In order to integrate sustainable equipment in perfect harmony with the project environment, the boat hotel was equipped with the Slim flush plate and the in-wall cistern OLI74 Plus Sanitarblock.





PLAIN

Simplicity at its finest. An ABS flush plate for in-wall cisterns with a minimalist design that combines a reduced thickness (6.5mm) with a high resistance to shocks and scratches. Contrary to its name, Plain stands out for the original way in which it distinguishes the dual flush buttons, one concave button and the other convex.



RIVER

An ABS flush plate for in-wall cisterns that perfectly distinguishes between the full flush and the half flush.





RIA START/STOP

OLI has a model that responds to the concern of protecting any environment against the spread of bacteria, especially when thinking about bathrooms in hospitals, senior homes or any other public space.



METAL

The strength of metal. Maximum resistance. Metal is made from the strongest materials and is vandal resistant which makes it perfect for installation in public bathrooms.





880876
eLINE Brushed

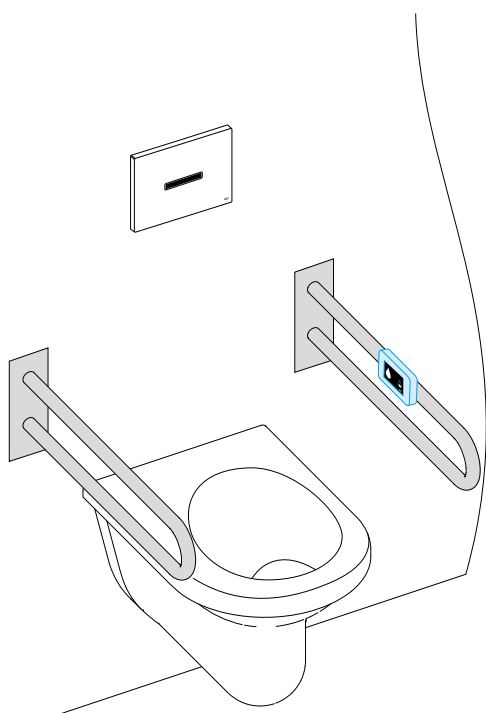

eLine is also suitable for bathrooms prepared for people with reduced mobility, thanks to its incorporated technology that allows to do the flush with a remote control. This remote control is installed in the support bars and is connected to the flush plate. Through the remote control, the user can choose the desired flush (full or half flush).



eLINE

OLI continues to differentiate the brand by offering trust flush plates for any situation. From infrared sensors that allow flushing without having to touch the flush plate to high quality steel that is highly resistant and vandal proof for public bathrooms.

Matching urinal flush plate also available.
(See page 193 for more information)





Matching urinal flush plate also available.
(See page 193 for more information)



ELECTRA III

High-tech inside and out. Equipped with an infrared sensor, Electra III allows the activation of the flush without touching the flush plate and also a manual override. This leads to greater hygiene and effortless use.





ELECTRA II



Equipped with an infrared sensor, Electra II allows the activation of the flush without touching the flush plate. This leads to greater hygiene and effortless use.

Matching urinal flush plate also available. (See page 193 for more information)



ELECTRA I



OLI continues to differentiate by offering stainless steel flush plates in order to build trust and guarantees quality. This flush plate is vandal resistant and a great solution for public bathrooms.

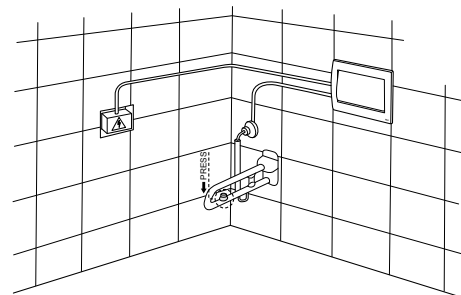



879120
eAQUA URINAL Inox AC



eAQUA URINAL

Stainless steel single flush urinal flush plate with a two year warranty. Available with a 24 or 48 hour hygienic flush. Combines perfectly with the Electra range of flush plates for in-wall cisterns.

Matching ELECTRA flush plate also available. (See page 190 for more information)

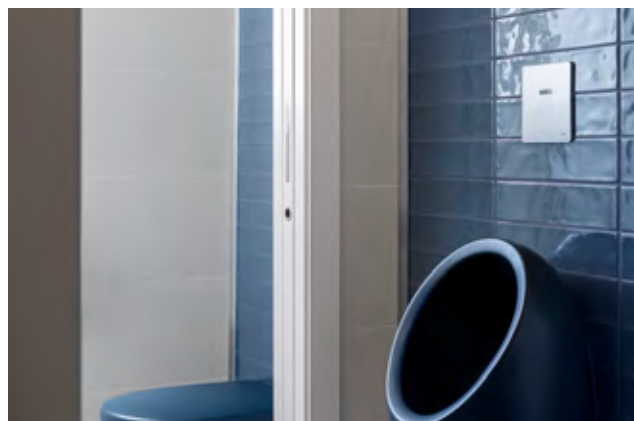

RESTAURANT CLUBE DE VELA DA COSTA NOVA, AVEIRO, PORTUGAL

The Costa Nova Sailing Club, one of the oldest nautical clubs in the Ria de Aveiro estuary area, were projected by Ferreira Arquitectos. This restaurant was divided into 3 main spaces: the restaurant, the club member's bar and the terrace. Their bathrooms are equipped with eAqua Urinal flush plates.





SM15 URINAL

SM15 is a tempered white glass, 147mm by 147mm, and is ideal for a smooth application on walls covered with traditional Portuguese tiles. The SM15 is installed surface-even with the wall for a seamless and elegant look.

Matching SM15 flush plate also available.
(See page 160 for more information)

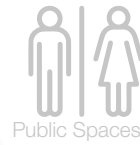

GLOBE URINAL

ABS flush plate: high resistance to scratches. Combines perfectly with the Globe range of flush plates for in-wall cisterns. Globe Urinal white is a flush fluxometer whose final finish is antibacterial since its coating inhibits the growth of microorganisms such as bacteria, fungi or algae.

Matching GLOBE flush plate also available.
(See page 182 for more information)





BLINK URINAL

Stainless steel single flush for urinals.
Combines perfectly with the Blink flush plates for in-wall cisterns.

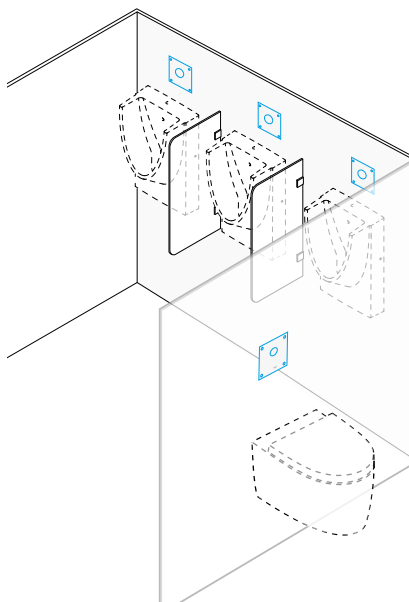
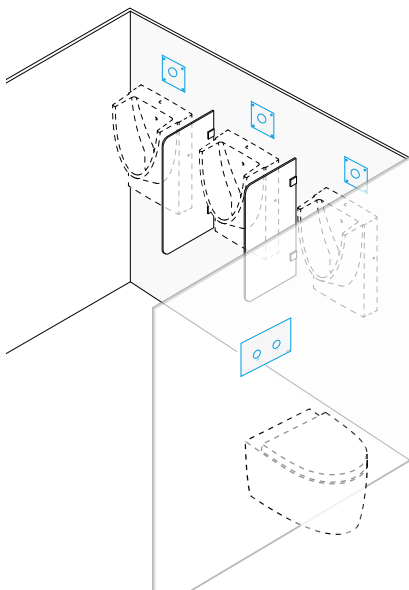

Matching BLINK flush plate also available.
(See page 171 for more information)



Matching BLINK II flush plate also available.
(See page 171 for more information)





EASY DUAL

Easy Dual promotes hygiene and is ideal for people with reduced mobility. The protruding buttons are easy to push and the full flush or the half flush can be easily activated.

COMPLIANT WITH SAFETY REGULATIONS AGAINST FIRE AND PANIC HAZARDS IN PUBLIC BUILDINGS (ERP) - ARTICLE CO 31

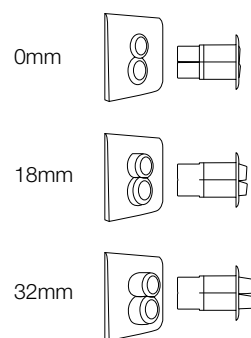



KIT DUPLEX

The KIT DUPLEX gives the possibility of combining two pneumatic flush plates in two different locations. This solution is compatible with OLI74 PLUS, EXPERT PLUS and QUADRA PLUS.

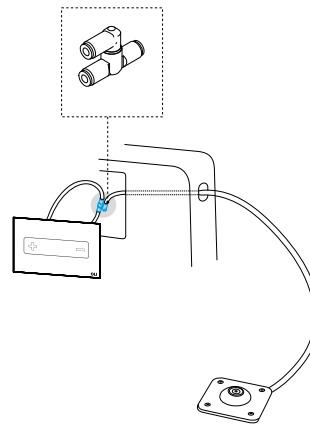

FOOT CONTROL FLOOR

Improve the hygiene at a public bathroom. A foot flush attachment can help stay clear of germs. This product is installed in floor.

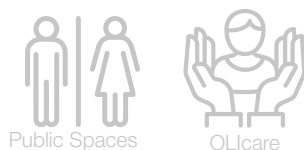

FOOT CONTROL WALL

This product is installed in wall and allows the user to flush a toilet using a foot pedal connected to the flushing cistern.

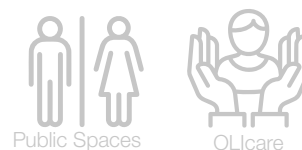

TECHNICAL INFORMATION



LESS IS MORE

Mechanical flush plate

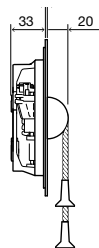
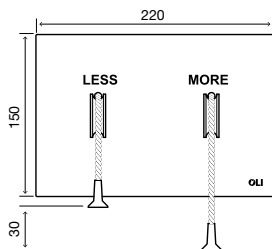

GENERAL FEATURES

- Design by Architect Alessio Pinto;
- Stainless steel material, black, white, brushed or polished;
- Nylon cords on grey;
- Mechanical actuation;
- Front application;
- Low actuation force <17 N;
- 2mm thick.

TRUMPET

Pneumatic flush plate

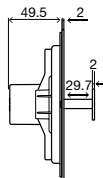
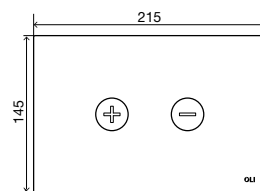

GENERAL FEATURES

- Designed by Architect Siza Vieira;
- Stainless steel material;
- Pneumatic actuation;
- Actuation force <20N;
- 2mm thick.

SM15

Pneumatic flush plate

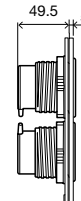
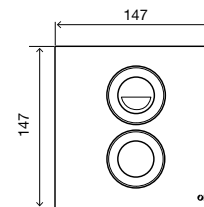

GENERAL FEATURES

- Designed by Architect Souto de Moura;
- White tempered glass material;
- Installation in the surface wall with 150x150mm tiles;
- Pneumatic actuation;
- Actuation force <20N;
- 5mm thick.

INO-X 02

Mechanical flush plate

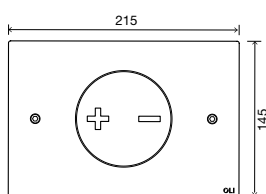

GENERAL FEATURES

- Designed by Architect Romano Adolini;
- Stainless steel material;
- Mechanical actuation;
- Actuation force < 20 N;
- Tiltable button;
- Vandal resistant;
- 2mm thick.

INO-X 06

Mechanical flush plate

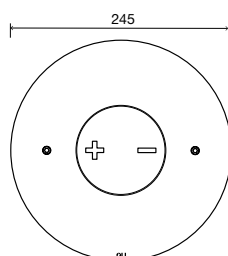

GENERAL FEATURES

- Designed by Architect Romano Adolini;
- Stainless steel material;
- Mechanical actuation;
- Actuation force < 20 N;
- Tiltable button;
- Vandal resistant;
- 2mm thick.

MOON

No-touch flush plate

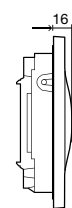
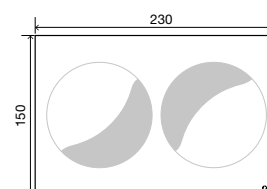

GENERAL FEATURES

- One-piece in white or black ceramic material;
- No-touch actuation through capacitive sensors;
- Hygienic and easy to clean;
- Compatible with Hydroboost or AC system;
- Anti-error electronic connections;
- Waterproof connectors;
- 16mm thick.

TRIBE

No-Touch flush plate

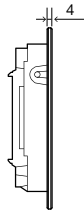
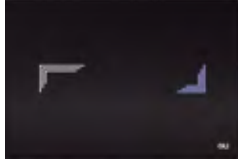

GENERAL FEATURES

- One-piece tempered glass;
- No-Touch actuation through capacitive sensors with led signs, multiple colours available;
- Hygienic and easy to clean;
- Compatible with Hydroboost or AC system;
- Anti-error electronic connections;
- Waterproof connectors;
- 4mm thick.

GLASSY

No-Touch flush plate

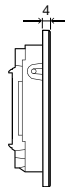
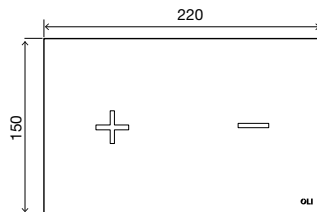
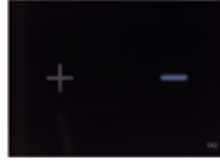

GENERAL FEATURES

- One-piece tempered glass;
- No-Touch actuation through capacitive sensors with led signs, multiple colours available;
- Hygienic and easy to clean;
- Compatible with Hydroboost or AC system;
- Hygienic and easy to clean;
- Anti-error electronic connections;
- Waterproof connectors;
- 4mm thick.

OCEANIA

Mechanic flush plate

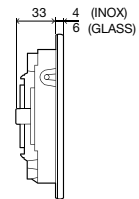
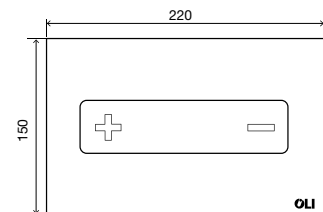
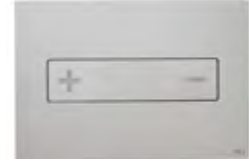

GENERAL FEATURES

- Stainless steel or tempered glass material;
- Mechanical actuation;
- Actuation force < 20 N;
- Tilttable button;
- Vandal resistant;
- Different finishing possibilities and combinations:
- 4mm thick (steel);
- 6mm thick (glass).

OCEANIA

Pneumatic flush plate

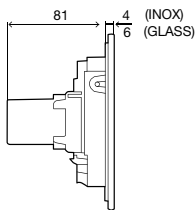
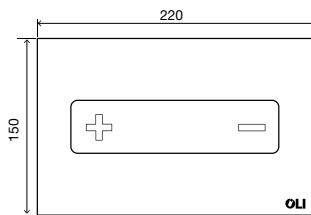

GENERAL FEATURES

- Stainless steel or tempered glass material;
- Pneumatic actuation;
- Actuation force < 20 N;
- Tilttable button;
- Vandal resistant;
- Different finishing possibilities and combinations:
- 4mm thick (steel);
- 6mm thick (glass).

MIA

Mechanic flush plate

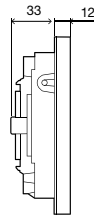
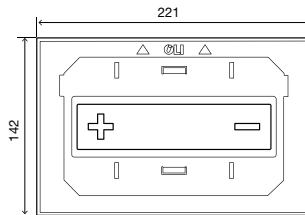

GENERAL FEATURES

- Customizable flush plate;
- 10mm material thick for the finishing;
- Stainless steel frame;
- Different finishing possibilities;
- Mechanic actuation;
- Actuation force < 20 N;
- Tilttable button;
- Vandal resistant;
- 12mm thick.

MIA

Pneumatic flush plate

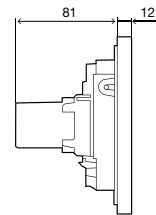
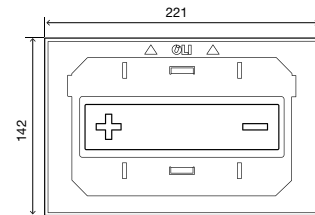

GENERAL FEATURES

- Customizable flush plate;
- 10mm material thick for the finishing;
- Stainless steel frame;
- Different finishing possibilities;
- Pneumatic actuation;
- Actuation force < 20 N;
- Tilttable button;
- Vandal resistant;
- 12mm thick.

BLINK

Pneumatic flush plate

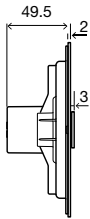
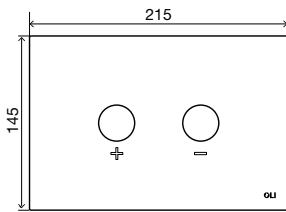

GENERAL FEATURES

- Stainless steel material;
- Pneumatic actuation;
- Actuation force <20N;
- 2mm thick.

BLINK II

Mechanical flush fluxometer

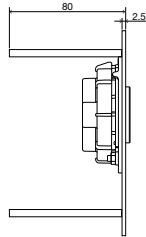
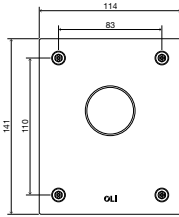

GENERAL FEATURES

- Mechanically actuated flush plate for toilet fluxometer;
- Stainless steel flush plate;
- Single flush;
- Vandal-resistant;
- TORX security screws (+bit);
- The concealed pre installation has to be installed before closing the wall;
- Compatible with WC frame;
- Available for wall-hung or floor toilets;
- 2.5mm thick.

TOILET CONCEALED PRE INSTALLATION

- **SOLD SEPARATELY**
- Flow pressure: 1,2 to 5 bar, max.
- resting pressure 8 bar;
- Flush volume: 1-1,3 l/s;
- Fitting connection DN20 G 3/4 external thread right.

SEAMLESS

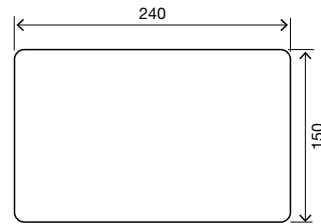

GENERAL FEATURES

- Inspection plate;
- Stainless steel material;
- Customize with your preferred finishing;
- Compatible with pneumatic in-wall cisterns;
- Vandal resistant;
- 0.5mm thick.

INSPECTION PLATE

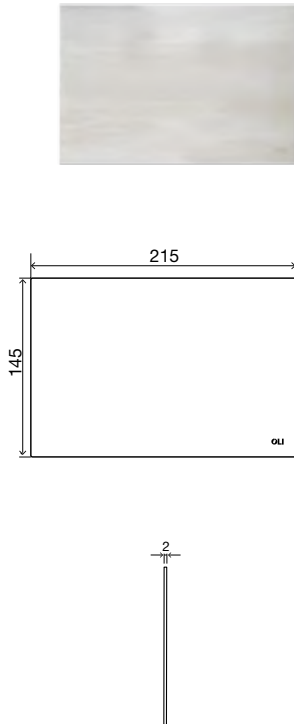

GENERAL FEATURES

- Inspection plate;
- Stainless steel material;
- Compatible with pneumatic in-wall cisterns;
- Vandal resistant;
- 2mm thick.

SPHERA*

Pneumatic flush plate



GENERAL FEATURES

- Polished chrome ABS material;
- Single flush;
- Pneumatic actuation;
- For drywall installations;
- An inspection plate should be applied to ensure the acces to the cistern;
- 2mm thick.

PNEUMATIC ACTUATOR*

In wall salient pneumatic

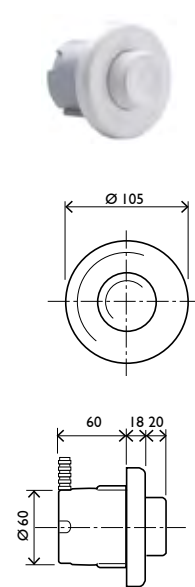

GENERAL FEATURES

- White ABS material;
- Single flush;
- Pneumatic actuation;
- An inspection plate should be applied to ensure the acces to the cistern;
- 38mm thick.

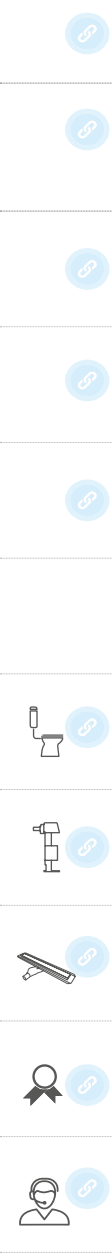

PNEUMATIC ACTUATOR*

In wall pneumatic

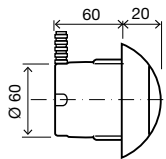
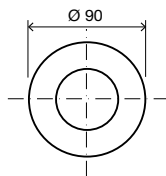

MINI TREND*

Pneumatic flush plate

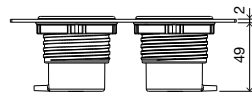
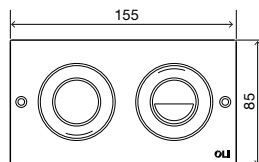

MONO TREND*

Pneumatic flush plate

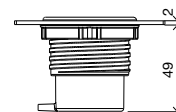
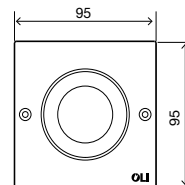

GENERAL FEATURES

- White ABS material;
- Single flush;
- Pneumatic actuation;
- An inspection plate should be applied to ensure the acces to the cistern;
- 20mm thick.

GENERAL FEATURES

- Polished chrome stainless steel material;
- Pneumatic actuation;
- For dry wall installations;
- Vandal resistant;
- Pneumatic connectors supplied;
- An inspection plate should be applied to ensure the acces to the cistern;
- 2mm thick.

GENERAL FEATURES

- Polished chrome stainless steel material;
- Single flush;
- Pneumatic actuation;
- For dry wall installations;
- Vandal resistant;
- An inspection plate should be applied to ensure the acces to the cistern;
- 2mm thick.

SALINA

Pneumatic flush plate

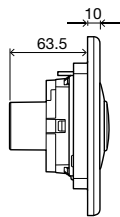
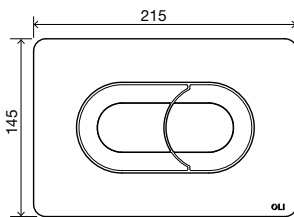

GENERAL FEATURES

- ABS flush plate: high resistance to scratches;
- Pneumatic actuation;
- Actuation force < 20 N;
- 10mm thick.

KARISMA

Pneumatic flush plate

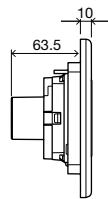
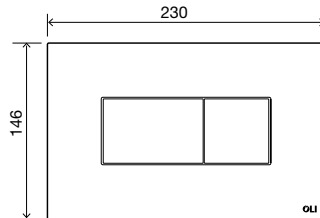
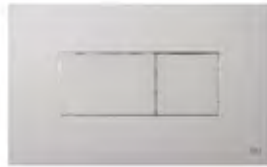

GENERAL FEATURES

- ABS flush plate: high resistance to scratches;
- Pneumatic actuation;
- Actuation force < 20 N;
- 10mm thick.

RIA

RIA START/STOP

Mechanic flush plate

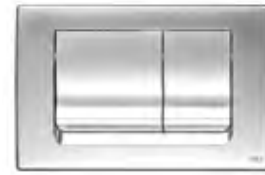

RIA



RIA START/STOP

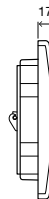
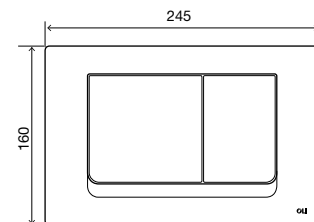

GENERAL FEATURES

- ABS flush plate: high resistance to scratches;
- Anti-bacterial finishing available;
- Mechanical actuation;
- Dual flush or single flush;
- Actuation force < 20 N;
- 17mm thick.



GLAM

Mechanic flush plate

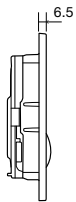
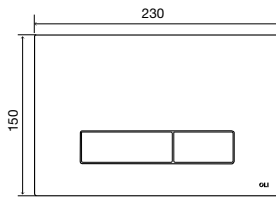

GENERAL FEATURES

- ABS flush plate: high resistance to scratches;
- Mechanical actuation;
- OLIpure compatible version;
- Actuation force < 20 N;
- 6.5mm thick.

NARROW

Mechanic flush plate

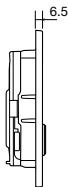
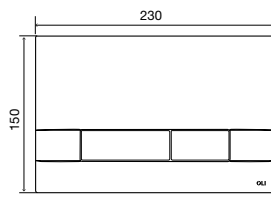

GENERAL FEATURES

- ABS flush plate: high resistance to scratches;
- Mechanical actuation;
- OLIpure compatible version;
- Actuation force < 20 N;
- 6.5mm thick.

GLOBE

Mechanic flush plate

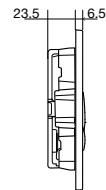
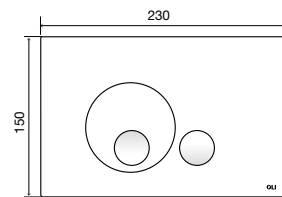

GENERAL FEATURES

- ABS flush plate: high resistance to scratches;
- Mechanical actuation;
- Actuation force < 20 N;
- 6.5mm thick.

IPLATE

Mechanic flush plate

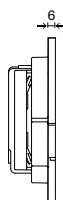
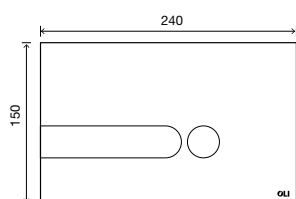

GENERAL FEATURES

- ABS flush plate: high resistance to scratches;
- Mechanical actuation;
- Actuation force < 20 N;
- Wide range of colours and combinations;
- Possibility of replacing the control buttons with kit elegance and kit fantasy;
- 6 mm thick;

SLIM

Mechanic flush plate

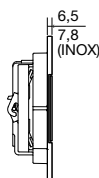
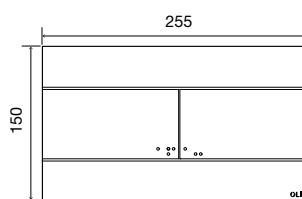

GENERAL FEATURES

- ABS flush plate: high resistance to scratches;
- Mechanical actuation;
- Actuation force < 20 N;
- 6.5mm thick.

GENERAL FEATURES SLIM INOX

- ABS control plate with brushed Stainless steel cover;
- Higher resistance to scratches;
- 7.8 mm thick.

PLAIN

Mechanic flush plate

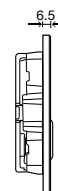
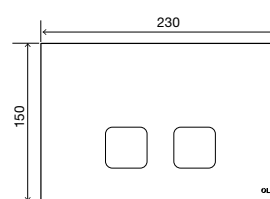

GENERAL FEATURES

- ABS flush plate: high resistance to scratches;
- Mechanical actuation;
- Actuation force < 20 N;
- 6.5mm thick.



RIVER

Mechanic flush plate

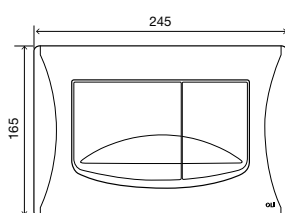

GENERAL FEATURES

- ABS flush plate: high resistance to scratches;
- Mechanical actuation;
- Actuation force < 20 N;
- 19mm thick.

METAL

Mechanic flush plate

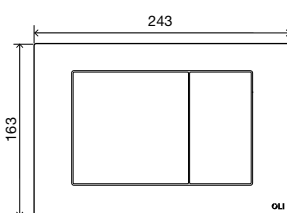
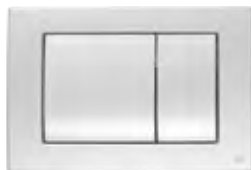

GENERAL FEATURES

- Zamac material;
- Mechanical actuation;
- Actuation force < 20 N;
- Vandal resistant;
- 17mm thick.

eLINE

Electronic flush plate

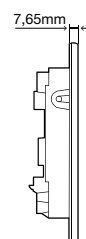
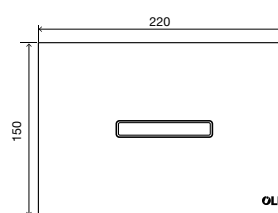

GENERAL FEATURES

- Brushed stainless steel material;
- Dual flush (<60s half flush; >60s full flush);
- Infrared sensor;
- Compatible with electronic in wall cisterns;
- Electric power connection (adapter 230V/12V not included);
- Configurable hygienic discharge;
- Configurable pre-discharge;
- Infrared sensor with detection up to 900mm;
- Bluetooth version allows a statistical record of discharges;
- Radio version allows a remote actuation;
- 8mm thick.

ELECTRA III

Electronic flush plate

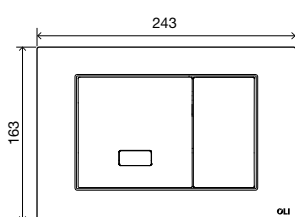

GENERAL FEATURES

- Polished chrome Zamac material;
- Dual flush (<60s half flush; >60s full flush);
- Infrared sensor or mechanical actuation;
- Compatible with electronic in wall cisterns;
- Electric power connection (adapter 230V/12V not included);
- Vandal resistant;
- 17mm thick.

ELECTRA II

Electronic flush plate

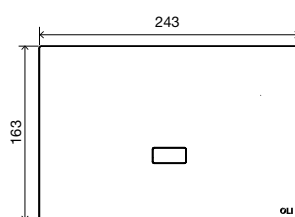

GENERAL FEATURES

- Polished chrome Zamac material;
- Dual flush (<60s half flush; >60s full flush);
- Infrared sensor;
- Compatible with electronic in wall cisterns;
- Electric power connection (adapter 230V/12V not included);
- Vandal resistant;
- 17mm thick.

ELECTRA I

Electronic flush plate

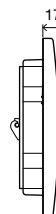
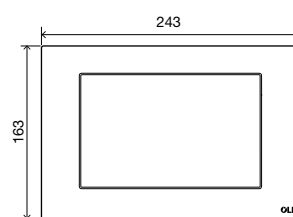

GENERAL FEATURES

- Polished chrome Zamac material;
- Single flush;
- Actuation by switch (not included) or mechanical;
- Electric power connection (adapter 230V/12V not included);
- Connecting cable for switch (4m included);
- Compatible with electronic in wall cisterns;
- Vandal resistant;
- 17mm thick.



BLINK

Urinal flush plate

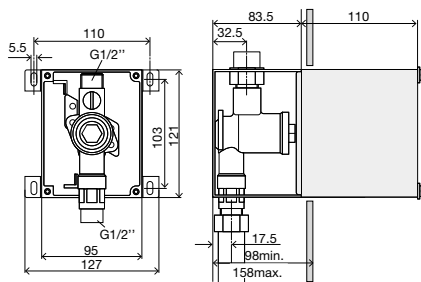
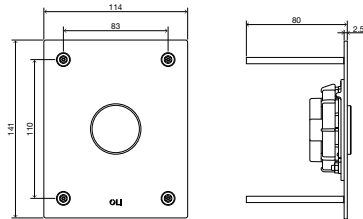

GENERAL FEATURES

- Stainless steel flush plate;
- Single flush;
- Mechanically actuated urinal plate for flush valve;
- Vandal-resistant;
- TORX security screws (+bit);
- The flush valve has to be installed before closing the wall;
- Compatible with ECO URINAL FRAME, URINAL
- Sanitarblock and DOUBLE FRAME WC/URINAL/ WASHBASIN;
- 2.5mm thick.

URINAL CONCEALED PRE INSTALLATION

- Adjustable flow;
- Flow pressure: 0.8 – 5 bar;
- Flush volume: 0.3 l/s;
- G 1/2" water connection;
- Protection cover 110mm;
- Pre-assembled water path with isolating valve;
- Sealing plug.

SM15

Urinal flush plate

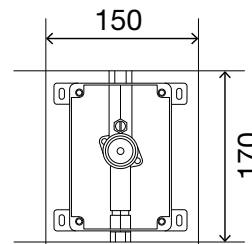
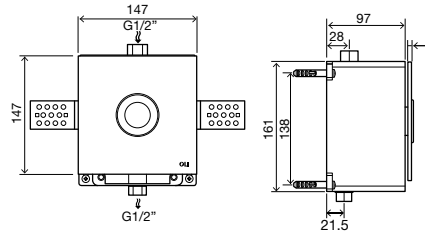

GENERAL FEATURES

- White tempered glass material;
- Single flush;
- Mechanically actuated urinal plate for flush valve;
- Adjustable flush time;
- Adjustable flow;
- Operating pressure ≥ 3 bar;
- G 1/2" water connections;
- Compatible with ECO URINAL FRAME, URINAL Sanitarblock and DOUBLE FRAME WC/URINAL/ WASHBASIN;
- The flush valve has to be installed before closing the wall;
- Urinal concealed pre-installation included;
- 5mm thick.

GLOBE

Urinal flush plate

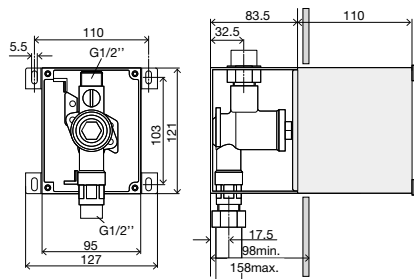
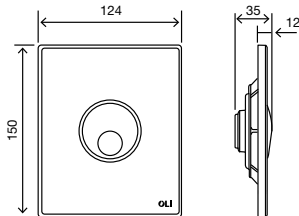

GENERAL FEATURES

- ABS flush plate: high resistance to scratches;
- Single flush;
- Mechanically actuated urinal plate for flush valve;
- Vandal-resistant;
- TORX security screws (+bit);
- The flush valve has to be installed before closing the wall;
- Compatible with ECO URINAL FRAME, URINAL Sanitarblock and DOUBLE FRAME WC/URINAL/ WASHBASIN;
- 2.5mm thick.

URINAL CONCEALED PRE INSTALLATION

- Adjustable flow;
- Flow pressure: 0.8 – 5 bar;
- Flush volume: 0.3 l/s;
- G 1/2" water connection;
- Protection cover 110mm;
- Pre-assembled water path with isolating valve;
- Sealing plug.

eAQUA

Urinal flush plate

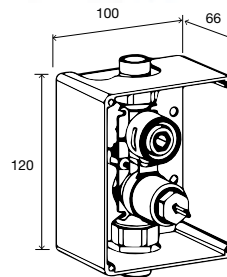
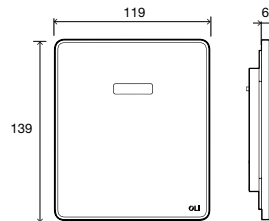

GENERAL FEATURES

- Brushed stainless-steel;
- Double infrared sensors (with automatic setting feature);
- Temporary-off (cleaning) and short-on (manual flush) activated with touch;
- Flush time and sensor sensitivity adjustable with touch;
- 24- or 48-hour hygienic flush and pre-flush activate with touch;
- The flush valve has to be installed before closing the wall;
- Compatible with ECO URINAL FRAME, URINAL Sanitarblock and DOUBLE FRAME WC/URINAL/ WASHBASIN;
- Vandal resistant;
- 6mm thick.

URINAL CONCEALED PRE INSTALLATION

- Operating pressure: 0.3 - 10 bar;
- Flow rate: ca. 20 l/min. (3 bar);
- 6V Lithium CRP 2 (standard: life time up to 4 years) / mains power supply 230V/6V;
- Standards: DIN EN 200; CE.

FOOT CONTROL FLOOR

Pneumatic flush plate

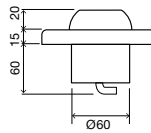
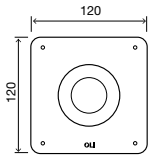

FOOT CONTROL WALL

Pneumatic flush plate

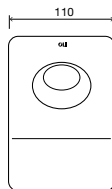
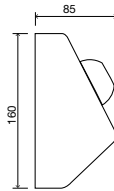

EASY DUAL

Mechanic flush plate

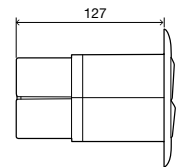
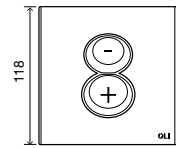

GENERAL FEATURES

- Stainless steel material;
- Floor installation;
- Single flush;
- Pneumatic actuation;
- An inspection plate should be applied to ensure the access to the cistern;
- Anti-sliding push button;
- Vandal resistant;
- 35mm thick.

GENERAL FEATURES

- Stainless steel material;
- Wall installation;
- Single flush;
- Pneumatic actuation;
- An inspection plate should be applied to ensure the access to the cistern;
- Anti-sliding push button;
- Vandal resistant;
- 85mm thick.

GENERAL FEATURES

- ABS flush plate: high resistance to scratches;
- Pneumatic actuation;
- Vandal resistant;
- Adjustable buttons: 0mm, 18mm or 32mm;
- Compliant with safety regulations against fire (ERP) Article CO 31.

ACCESSORIES



PROTECTION PIPE

- Protection pipe 1.8m for pneumatic connections.

CODE	DESCRIPTION
049544	1.8m protection pipe



PNEUMATIC PIPES

- Pneumatic pipes x2;
- 3m each.

CODE	DESCRIPTION
043234	3m Pneumatic pipe



SERVOMOTOR

- Servomotor block;
- eLINE flush plate.

CODE	DESCRIPTION
885032	Servomotor Block



POWER SUPPLY ELINE

- Input: 100 - 240 V AC; 50/60Hz;
- Output: 7 V DC 3A;
- eLINE flush plate.

CODE	DESCRIPTION
885033	Power supply



REMOTE CONTROL

- Radio remote control;
- Dual flush;
- Capacitive buttons.

CODE	DESCRIPTION
884193	Remote control



POWER SUPPLY

- Input: 100 - 240 V AC; 50/60Hz;
- Output: 12 V DC 1,5A;
- ELECTRA flush plates.

CODE	DESCRIPTION
079260	Power supply



RADIO RECEPTOR

- Radio receptor control;
- Flushing by remote control.

CODE	DESCRIPTION
883578	Radio Receptor



ELINE BLUETOOTH RECEPTOR

- Statistical record of discharges;
- App interaction;
- Easy and useful service for facility managers.

CODE	DESCRIPTION
883582	eLINE Bluetooth Receptor



KIT DUPLEX

- 2 points of actuation on the same cistern;
- Only for pneumatic flush plates;
- Single flush.

CODE	DESCRIPTION
216252	Kit duplex



PART NUMBER GUIDE

White □	Black ■	Red ▸	Anthracite ◼	Gold ◼	White Gold ◼	Taupe ⌘	Polished chrome ◻	Brushed ◻	Bronze/Copper ◼	Gun Metal ◼	Grey soft-touch ◼	Black soft-touch ■
------------	------------	----------	-----------------	-----------	-----------------	------------	----------------------	--------------	--------------------	----------------	----------------------	-----------------------



No-touch

MOON	878848	878981	-	-	-	-	-	-	-	-	-	-	-
TRIBE	879065	879063	879066	879068	879067	-	879071	-	-	-	-	-	-
GLASSY	878849	878850	878703	878702	878700	-	878701	-	-	-	-	-	-



Mechanic

LESS is MORE	883526	883527	-	-	-	-	-	883524	883525	-	-	-	-
BLINK II Toilet flush fluxometer	-	-	-	-	-	-	-	-	884967 flush plate 885101 concealed flush 885044 Floor toilet kit	-	-	-	-
INO-X 02	-	-	-	-	-	-	-	660002	661002	-	-	-	-
INO-X 06	-	-	-	-	-	-	-	660006	661006	-	-	-	-
OCEANIA	054558 steel button 054554 glass	054562 steel button 054557 glass	-	-	-	-	-	054561	054564	-	-	-	-
OCEANIA MIA	054563	-	-	-	-	-	-	-	-	-	-	-	-
GLOBE	152949	-	-	-	152954	-	-	152950	152951	-	-	152953	152952
SLIM	659041	-	-	-	154962	-	-	659044	659046	-	-	010216	659055
NARROW	152939	-	-	-	-	-	-	152940	152941	-	-	-	152942
GLAM	139184	-	-	-	-	-	-	139185	139186	-	-	-	139187
IPLATE	013589	-	015886 Kit fantasy	015887 Kit elegance	-	-	-	670004	670006	-	-	-	670005
PLAIN	070826	-	-	-	-	-	-	070827	070828	-	-	-	070829
RIA	640591	-	-	-	-	-	-	640584	640586	-	-	-	-
RIA STOP	010234	-	-	-	-	-	-	010244	-	-	-	-	-
RIVER	638501	-	-	-	638508	-	-	638504	638506	-	-	-	-
METAL	-	-	-	-	-	-	-	011418	656006	-	-	-	-



Pneumatic

TRUMPET	-	-	-	-	-	878783	-	046199	046198	878784	-	-	-
OCEANIA	054993 steel button 054989 glass	054996 steel button 054992 glass	-	-	-	-	-	054998	054988	-	-	-	-
OCEANIA MIA	054997	-	-	-	-	-	-	-	-	-	-	-	-
BLINK	216621	878489	-	-	883246	878781	-	154963	093399	878782	882567	-	-
SM15	022238	-	-	-	-	-	-	-	-	-	-	-	-
KARISMA	641001	-	-	-	-	-	-	641004	641006	-	-	-	641015
SALINA	640081	-	-	-	-	-	-	640084	640086	-	-	-	640097
EASY DUAL	011640	-	-	-	-	-	-	011642	-	-	-	-	-

WxDxH	Weight	Qt.	Multiple Box Dim	Weight	Qty per Pallet	Pallet Height	Pallet Width	Pallet Length	Weight

252x178x109	1.34	16	595x391x500	23.68	320	2.66	0.8	1.2	473.6
252x178x109	1.02	16	595x391x500	18.56	320	2.66	0.8	1.2	371.2
252x178x109	1.01	16	595x391x500	18.24	320	2.66	0.8	1.2	364.8

252x178x109	1.17	16	595x391x500	20.64	320	2.66	0.8	1.2	412.8
266x190x55	0.63	14	595x391x250	10.08	448	2.16	0.8	1.2	322.56
300x300x45	1	-	-	-	-	-	-	-	-
300x300x45	2	-	-	-	-	-	-	-	-
252x178x109	0.42	16	595x391x500	9.12	320	2.66	0.8	1.2	182.4
252x178x109	0.72	16	595x391x500	14.24	320	2.66	0.8	1.2	284.8
266x190x55	0.37	34	595x391x500	14.62	680	2.65	0.8	1.2	292.4
266x190x55	0.43	34	595x391x500	16.32	680	2.66	0.8	1.2	326.4
266x190x55	0.35	34	595x391x500	13.94	680	2.66	0.8	1.2	278.8
266x190x55	0.35	34	595x391x500	13.94	680	2.66	0.8	1.2	278.8
266x190x55	0.37	34	595x391x500	14.62	680	2.66x	0.8	1.2	292.4
266x190x55	0.36	34	595x391x500	14.28	680	2.66	0.8	1.2	285.6
270x190x57	0.43	22	540x330x392	10.56	550	2.12	0.87	1.2	264
270x190x57	0.43	22	540x330x392	10.56	550	2.12	0.87	1.2	264
266x190x55	0.44	20	540x330x392	9.8	500	2.12	0.87	1.2	245
266x190x55	1.11	14	595x391x250	16.66	560	2.66	0.8	1.2	666.4

261x187x114	0.55	16	595x391x500	11.2	320	2.66	0.8	1.2	224
252x178x109	0.88	16	595x391x500	16.48	320	2.66	0.8	1.2	329.6
252x178x109	0.76	16	595x391x500	14.88	320	2.66	0.8	1.2	297.6
240x162x90	0.81	28	595x391x500	24.64	560	2.66	0.8	1.2	492.8
461x161x71	1.02	8	485x351x345	9.44	192	1.54	1	1.2	226.56
260x180x97	0.34	20	595x391x500	8.8	320	2.16	0.8	1.2	140.8
260x180x97	0.46	20	595x391x500	11	320	2.16	0.8	1.2	176
230X200X120	0.99	10	595x391x500	11	200	1.9	1	1.2	232

PART NUMBER GUIDE

	White □	Black ■	Red ▴	Anthracite ▣	Gold ▤	White Gold ▥	Taupe %	Polished chrome ▧	Brushed ▨	Bronze/ Copper ▩	Gun Metal ▪	Grey soft-touch ▫	Black soft-touch ▬
MONO TREND	-	-	-	-	-	-	-	-	23506	-	-	-	-
SPHERA+	-	-	-	-	-	-	-	605264	-	-	-	-	-
SPHERA-	-	-	-	-	-	-	-	605274	-	-	-	-	-
PNEUMATIC HAND	84794	-	-	-	-	-	-	605004	-	-	-	-	-
PNEUMATIC SALIENT HAND	718063	-	-	-	-	-	-	-	-	-	-	-	-
FOOT CONTROL FLOR	-	-	-	-	-	-	-	-	605201	-	-	-	-
FOOT CONTROL WALL	-	-	-	-	-	-	-	-	605301	-	-	-	-
SEAMLESS	-	-	-	-	-	-	-	-	880390	-	-	-	-
INSPECTION PLATE	-	-	-	-	-	-	-	207892	207893	-	-	-	-



Electronic

ELINE	-	-	-	-	-	-	-	-	880876 standard 883585 radio	-	-	-	-
ELECTRA I	-	-	-	-	-	-	-	079207	-	-	-	-	-
ELECTRA II	-	-	-	-	-	-	-	079205	-	-	-	-	-
ELECTRA III	-	-	-	-	-	-	-	079206	-	-	-	-	-



Urinol

BLINK URINAL	-	-	-	-	-	-	-	Blink 882264 883087 Concealed pre-instal- lation	-	-	-	-	-
SM15 URINAL	034265	-	-	-	-	-	-	-	-	-	-	-	-
EAQUA URINAL	-	-	-	-	-	-	-	-	879120 AC 879119 Batt 879123 Concealed pre-instal- lation	-	-	-	-
GLOBE URINAL	878466 883087 Con- cealed pre-in- stalla- tion	-	-	-	878822 883087 Con- cealed pre-in- stalla- tion	-	-	878818 883087 Concealed pre-instal- lation	878819 883087 Concealed pre-instal- lation	-	-	-	-



OLIpure

NARROW	148300	-	-	-	-	-	-	148301	148302	-	-	-	148303
GLAM	139178	-	-	-	-	-	-	139179	139186	-	-	-	139181



Vandal proof

SLIM INOX	-	-	-	-	-	-	-	-	057141	-	-	-	-
METAL	-	-	-	-	-	-	-	011418	656006	-	-	-	-

WxDxH	Weight	Qt.	Multiple Box Dim	Weight	Qty per Pallet	Pallet Height	Pallet Width	Pallet Length	Weight
260x180x97	0.49	20	595x391x500	11	400	2.66	0.8	1.2	228
260x180x97	0.34	20	595x391x500	9.4	240	1.66	0.8	1.2	112.8
260x180x97	0.34	20	595x391x500	9.4	240	1.66	0.8	1.2	112.8
260x180x97	0.41	20	595x391x500	10	400	2.16	1	1.2	200
260x180x97	0.41	20	595x391x500	10	400	2.16	1	1.2	200
-	0.2	15	595x391x435	3	300	2.3	0.8	1.2	60
-	0.2	15	595x391x435	3	300	2.3	0.8	1.2	60
266x190x55	0.46	34	595x391x500	17.34	680	2.66	0.8	1.2	346.8
266x190x55	0.68	34	595x391x500	24.82	680	2.66	0.8	1.2	496.4

260x180x97	0.81	20	595x391x500	19.2	400	2.66	0.8	1.2	384
266x190x55	1.11	14	595x391x250	16.66	560	2.66	0.8	1.2	666.4
266x190x55	1.11	14	595x391x250	16.66	560	2.66	0.8	1.2	666.4
266x190x55	1.11	14	595x391x250	16.66	560	2.66	0.8	1.2	666.4

266x190x55	0.63	14	595x391x250	10.08	448	2.16	0.8	1.2	322.56
261x187x114	1	16	595x391x500	16	320	2.66	0.8	1.2	320
215x215x135	1.26	6	595x391x250	9.06	96	1.15	0.8	1.2	144.96
385x183x125	1.6	-	-	-	240	2.66	0.8	1.2	278.4
261x187x114	1	16	595x391x500	16	320	2.66	0.8	1.2	320
266x190x55	0.36	14	595x391x250	6.3	448	2.16	0.8	1.2	201.6

260x180x97	0.88	20	595x391x500	19.8	400	2.66	0.8	1.2	396
260x180x97	0.89	20	595x391x500	20	400	2.66	0.8	1.2	400

266x190x55	0.52	14	595x391x500	16.32	560	2.66	0.8	1.2	341.6
266x190x55	1.11	14	595x391x250	16.66	560	2.66	0.8	1.2	666.4

EXPOSED FLUSH CISTERNS

OLI flush cisterns are made with bright thermoplastic material that is resistant to knocks and scratches. Some models are accessible in a wide range of colours, as well as the traditional white. They are available in three different versions: close-coupled; medium to low position and high position. The close-coupled version (fitted directly into the ceramic pan) is ideal for the replacement of ceramic cisterns.







880599
QUARZO OLIpure



QUARZO OLIPURE

Quarzo is a medium-low position cistern, in other words it is applied directly on the wall slightly above the toilet.

OLIpure the right solution for perfect hygiene in the bathroom.

Internal system that pumps cleaning liquid in each flush. This way the cleaning liquid is always in a closed circuit, unlike traditional cleaning tablets that are always in contact with water, causing possible damages to components in the cistern.



- Easy, fast and simple refilling of the cleaning liquid, through a small opening on the side of the cistern.
- Universal - Compatible with every WC liquid ** cleaning product;
- Long lasting, 450ml maximum capacity.



To insert the hygienic liquid on Quarzo exposed cistern you just need to open the side entry of the tank.



Ambiwave is the disinfectant liquid on OLIpure Kit and in Quarzo exposed cistern, however, you can acquire this separately. See page 229.



Just fill the tank with Ambiwave liquid or another toilet liquid on the market*, to keep the toilet clean and with a fresh atmosphere in the bathroom.



* If the water connection is in the back position, a bended connection pipe or flexible hose is needed.

**The use of chlorine-free liquid detergents with a viscosity between 150 and 300 cp (at 20 ° C) is recommended.



340221
ONIX PLUS 2 in 1



Onix Plus is a 2 in 1 cistern, it can be applied as a close-coupled cistern or a medium-low position cistern. In other words it can be applied directly on the toilet or directly on the wall slightly above the toilet. It is ideal for the replacement of ceramic cisterns.



ONIX PLUS CLOSE COUPLE APPLICATION

Onix Plus can be install directly on the toilet to create a perfect harmony between the plastic and ceramic.



ONIX PLUS MEDIUM-LOW APPLICATION

Onix Plus also includes the fixation system to apply it slightly away from the wall.



The cistern application allows an easy adjustment for all toilet fixation holes.





TOPAZIO DD

TOPAZIO DD is a cistern with square lines and with different finishings besides white (upon request). With 135mm of depth, this exposed cistern is the slimmest of OLI range and can be fixed to the wall and slightly away from the toilet.



ZAFFIRO DD

Available in white or in a wide range of colours (upon request), ZAFFIRO DD is a cistern with monoblock application, applied directly in the toilet, ideal to replace ceramic cisterns.





TURCHESE

Turchese is a high position cistern, in other words it is applied directly on the wall high above the toilet with a lever/puller.



OLISTYLE

OLISTYLE is a high position cistern, so it is applied directly on the wall high above the toilet with a lever/puller.



TOPAZIO

Topazio is a high position cistern, so it is applied directly on the wall high above the toilet with a lever/puller. The flush could be in the Lid push button or pneumatic button.

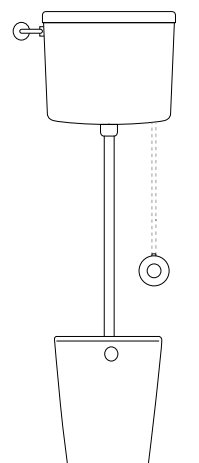
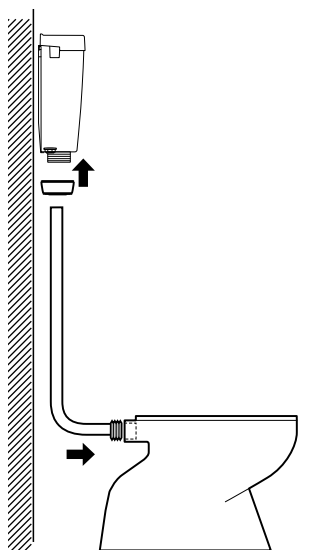

Single flush pneumatic actuator that is compatible with OLI exposed cisterns. This range have solution for installing outside the wall. See Page 229.



TECHNICAL INFORMATION

QUARZO

Medium-low Position

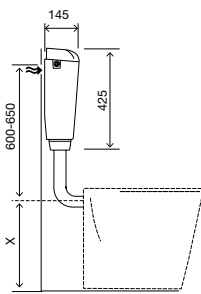
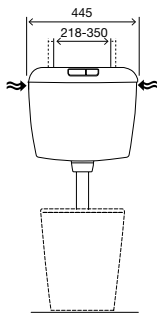

TOPAZIO DD

Medium-low Position

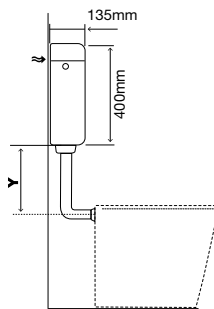
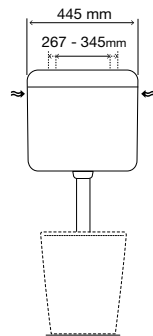

Y	MIN	MAX
Ø40	90	332
Ø44	90	230

ONIX PLUS

Medium-low/Close coupled application

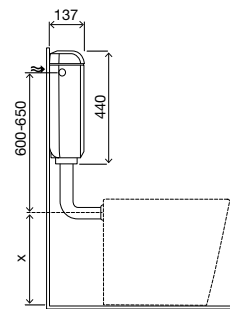
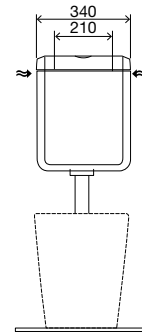

GENERAL FEATURES

- Dual flush 6/3 litres (adjustable to 9/4 litres in the outlet valve);
- Medium/low level installation;
- Acoustic and anti-condensation internal lining;
- Silent inlet valve;
- Adjustable wall fixation system;
- Water supply connections - Three positions;
- EN 14055 CE marking;
- White PS material;
- 145mm thick.

INCLUDED

- Flush pipe Ø50/40;
- Wall fixation accessories;
- Toilet connection rubber seal.

GENERAL FEATURES

- Dual flush 6/3 litres (adjustable to 9/4 litres in the outlet valve);
- Medium/low level installation;
- Acoustic and anti-condensation internal lining;
- Silent inlet valve;
- Adjustable wall fixation system;
- Water supply connections - Three positions;
- Some versions compliant with: KIWA;
- EN 14055 CE marking;
- White PS material;
- 135mm thick.

INCLUDED

- Flush pipe Ø50/40;
- Wall fixation accessories;
- Toilet connection rubber seal.

GENERAL FEATURES

- Dual flush 6/3 litres (adjustable to 4/2 litres in the outlet valve);
- Medium installation or close couple;
- Acoustic and anti-condensation internal lining;
- Delayed refilling inlet valve;
- Silent inlet valve;
- Water supply connections - Three positions;
- Some versions compliant with: KIWA;
- EN 14055 CE marking;
- White PS material;
- 137mm thick.

INCLUDED

- Close- couple fixation kit;
- Flush pipe Ø50/40 for medium-low level installation;
- Wall fixation accessories;
- Toilet connection rubber seal.

ZAFFIRO DD

Close-coupled

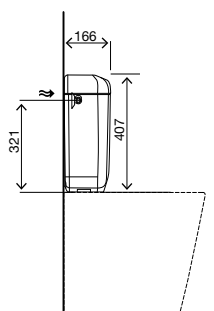
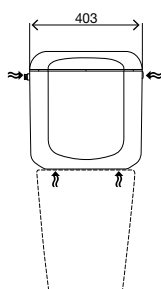

GENERAL FEATURES

- Dual flush 6/3 litres (adjustable to 9/4 litres in the outlet valve);
- Close couple installation;
- Acoustic and anti-condensation internal lining;
- Silent inlet valve;
- Water supply connections - Three positions;
- Some versions compliant with: KIWA;
- EN 14055 CE marking;
- White PS material;
- 166mm thick.

INCLUDED

- Close-couple fixation kit.

TURCHESE

High position

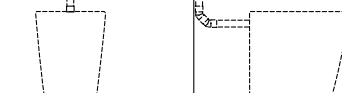
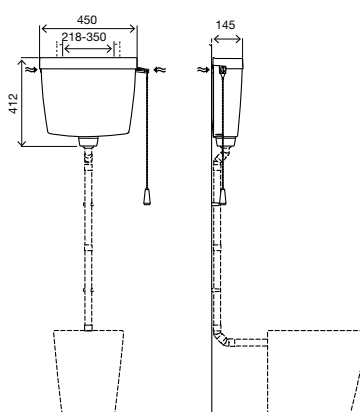

GENERAL FEATURES

- High level exposed tank with single flush 6 litres (adjustable to 9 litres in the inlet valve);
- Actuation in the push button or pulling a chain;
- High/Medium/low level installation;
- Acoustic and anti-condensation internal lining;
- Silent inlet valve;
- Adjustable wall fixation system;
- Water supply connections - Three positions;
- Compatible with Ø32 flush pipes;
- Pneumatic version available
- EN 14055 CE marking;
- White PS material;
- 145mm thick.

INCLUDED

- Chain for high level installation;
- Wall fixation accessories;
- Toilet connection rubber seal Ø32.

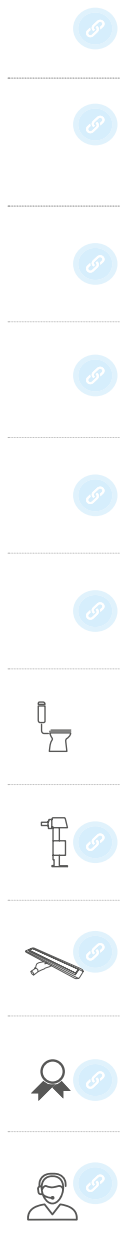

TECHNICAL INFORMATION

OLISTYLE

High position

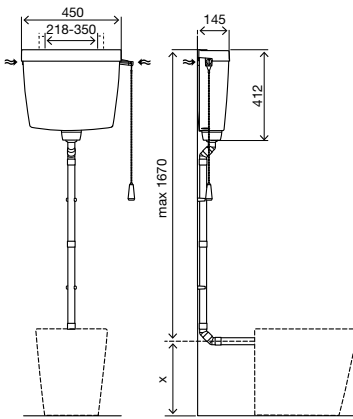

TOPAZIO

High position

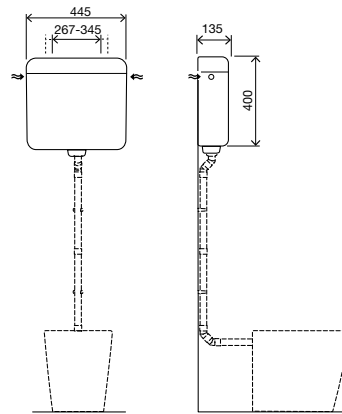

GENERAL FEATURES

- High level exposed tank with single flush 9 litres (adjustable to 6 litres in the inlet valve);
- Actuation in the push button or pulling a chain;
- High/Medium/low level installation;
- 145mm thick;
- Adjustable wall fixation system;
- Water supply connections - Three positions;
- EN 14055 CE marking;
- White PS material;
- 5 year warranty.

INCLUDED

- Chain for high level installation;
- 4 modular flush pipes Ø32;
- Wall fixation accessories;
- Toilet connection rubber seal Ø32.

GENERAL FEATURES

- High level exposed tank with single flush 9 litres (adjustable to 6 litres in the inlet valve);
- Actuation in the Lid push button or pneumatic button (pneumatic push buttons page 146);
- High/Medium/low level installation;
- Acoustic and anti-condensation internal lining;
- Silent inlet valve;
- 135mm thick;
- Adjustable wall fixation system;
- Water supply connections - Three positions;
- EN 14055 CE marking;
- White PS material;
- 5 year warranty.

INCLUDED

- Wall fixation accessories.

ACCESSORIES



FLUSH PIPE Ø50/32 15°

- Flush pipe set for high exposed cisterns;
- Height 1000mm;
- Toilet connection Ø32;
- Cistern connection Ø50.

CODE	DESCRIPTION
490601	Flush pipe for medium/high cisterns (complete)
490501	Flush pipe for medium/high cisterns (split)



MODULAR FLUSH PIPE

- Flush pipe modules for high exposed cisterns;
- 5 flush pipes Ø32;
- 3 flush pipe bend Ø32;
- Flush pipe bend connection Ø32/50;
- Flush pipe support with fixation screw.

CODE	DESCRIPTION
490881	Modular flush pipes for high/medium exposed cistern white



FLUSH PIPE Ø32

- Set for high exposed cisterns;
- 1 flush pipe 350mm Ø32;
- 1 flush pipe 500mm Ø32;
- 1 flush pipe 1000mm Ø32.

CODE	DESCRIPTION
490701	Modular flush pipes for high cistern white



FLUSH PIPE

- Medium/high installations.

CODE	DESCRIPTION
490301	Flush pipe H-600 L-210mm Ø32- white
490318	Flush pipe H-600 L-210mm Ø40- white
490401	Flush pipe H-1000 L-210mm Ø40- white



FLUSH PIPE

- Medium/Low installations.

CODE	DESCRIPTION
490001	Flush pipe H-325mm L-210mm Ø32- white
490101	Flush pipe H-325mm L-210mm Ø40- white
490130	Flush pipe H-325mm L-350mm Ø40- white



AMBIWAVE

- Liquid disinfectant for toilet;
- 450ml dosage;
- 12 units per pack.

CODE	DESCRIPTION
879955	Ambiwave-OLIpure



TOPAZIO PNEUMATIC KIT

- Pneumatic kit for Topazio exposed cistern;
- Push button not supply.

CODE	DESCRIPTION
087617	Topazio pneumatic kit



PNEUMATIC ACTUATOR



- Single flush;
- Pneumatic actuation;
- ABS material.

- Included:
- Fixing material;
 - Aesthetic covering pipe 1000m
 - Pneumatic flexible pipe 2500mm

CODE	DESCRIPTION
084801	Pneumatic actuator hand operated white
084802	Pneumatic actuator hand operated polished Chrome

PART NUMBER GUIDE

	 Dual Flush	 OLIpure	 Start/Stop	 Medium-low position	 Close coupled position	 High position	 Pneumatic version	 Silent inlet valve	 Anti-condensation lining	kiwa
QUARZO 	124427	880599	-	•	-	-	-	•	•	-
ONIX PLUS 	340221	-	-	•	•	-	-	•	•	•
TOPAZIO DD 	416501 416201 with stop valve	-	-	•	-	-	-	•	•	•
TOPAZIO 	-	-	413781	•	-	•	•	•	•	-
ZAFFIRO DD 	860758 425201 with stop valve	-	-	-	•	-	-	•	•	•
	002426 Bottom connection									
TURCHESE 	-	-	440051 440201 with stop valve	•	-	•	440881	•	•	-
OLISTYLE 	-	-	440141	•	-	•	-	-	-	-

 WxDxH	Weight	Qt.	 Multiple Box Dim	Weight	Qty per Pallet	Pallet Height	 Pallet Width	Pallet Length	Weight
453x143x441	2.83	5	764x474x460	16.1	75	2.45	1	1.24	241.5
353x143x456	2.79	5	767x380x491	15.8	75	2.44	0.8	1.2	237
446x144x446	3.29	-	-	-	65	2.39	0.8	1.2	226.85
446x144x446	3.25	-	-	-	65	2.39	0.8	1.2	224.25
408x176x431	3.01	-	-	-	48	2.04	0.8	1.2	168
456x146x430	2.7	-	-	-	68	2.31	0.8	1.2	183.6
456x146x430	2.75	-	-	-	52	1.88	0.8	1.2	156

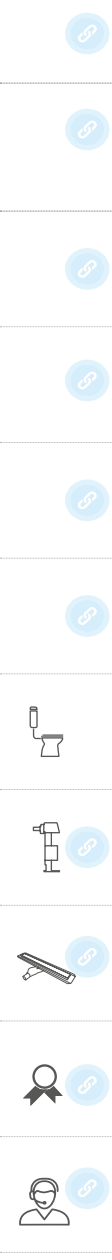

MECHANISMS





Universal inlet and outlet valves for ceramic cisterns

Easy and quick installation

OLI is a leading European producer of mechanisms for ceramic cisterns and its quality is recognized by the most important international bodies. The extremely silent inlet valves and the elevated performance levels of our outlet valves are tested under strict laboratory conditions before being introduced to the market.



135948
ATLAS-bag

883706
IVC100 PLUS 3/8" brass - box

OLI strives to offer sustainable products with a strong functional component. For that, it carries in product range, inlet valves compatible for either side or inferior connection.

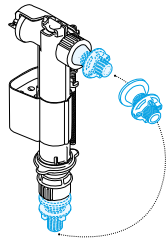
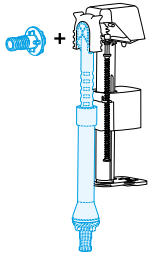

AZOR PLUS

The Azor Plus inlet valve has a delayed opening system, it only opens the water after the outlet valve closes. This system allows a water saving of up to 0.5 liters on average with each full flush, resulting in a daily average saving of 9 liters.

IVC100 PLUS

An inlet valve with both a bottom and side water supplied in the same inlet valve. Easy to install and easy maintenance with an integrated filter that can be cleaned without disconnecting from the water connection IVC100 Plus has a delayed opening system, it only opens the water after the flush valve closes. This system allows a water saving of up to 0.5 liters on average with each full flush, resulting in a daily average saving of 9 liters.

AG104 PLUS

Adapt to the new british certification WRAS, AG104 Plus presents high levels of performance thanks to its new and efficient anti backflow system, compatible with all in-wall, exposed or ceramic cisterns.

IVC102 PLUS

IVC102 Plus is a silent and ecological inlet valve. With class 1 level noise, IVC102 Plus incorporates an OLI's technology that enables air induction noise. The adjustable connection (1/2" brass (also available in plastic) or 15/16 in plastic) makes the IVC102 Plus the perfect solution for a wide range of ceramic cisterns.

INLET VALVE IN CLOSED POSITION

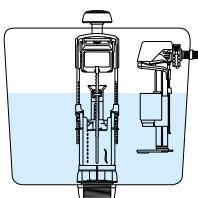

OPERATION MODE DUAL FLUSH

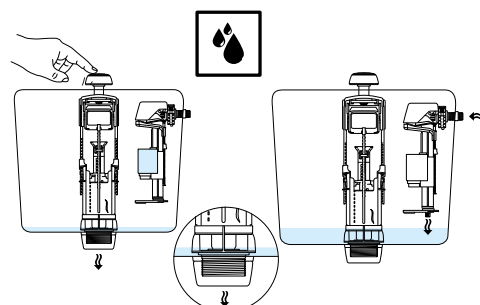

OPERATION MODE HALF FLUSH

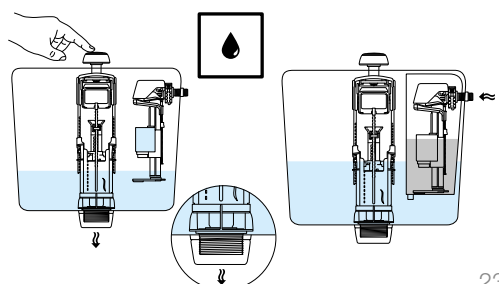



NANO PLUS

Nano is an inlet valve with high performances on dirty waters and a really efficient behaviour when tested with any pressure, thanks to counter hydraulic pressure system.



OLI ONE

This is the new inlet valve that comes to relieve every plumber challenge. Prepare to be compatible with all in-wall, exposed or ceramic cisterns.

The adaptors set with a plastic racord makes OLI ONE compatible with in-wall cisterns

The plastic shank accessory makes this inlet valve also compatible with exterior cisterns and ceramic cisterns.

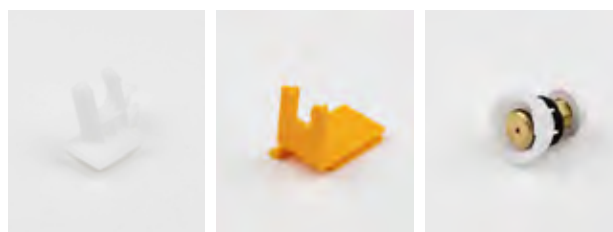



COMPACT

Since ever in OLI inlet valve range, COMPACT possesses a efficient and reliable counter-pressure system, thanks to its structural development, this is a side connection inlet valve.



JOLLY UNI

At OLI, new products are constantly being develop with the purpose of ensuring a high efficiency when exposed to any type of water. JOLLY UNI possesses a mechanic closing system of high performance and resistance.



UNI BOTTOM

UNI BOTTOM is a inlet valve for bottom water connection, available in 3/8 or 1/2 in brass or plastic connection, equip with a mechanical piston closing system.



Available in 3/8 or 1/2 brass or plastic connection.



Available in 3/8 or 1/2 in plastic connection.



AZOR SILENT

AZOR SILENT comes prepared for both bottom or side water connection. Easy to install and easy to mantain with an integrated filter that can be clean without disconnecting from the water connection.



Available in 3/8 or 1/2 brass or plastic connection.



NOTE: Mechanical anti-Backflow function available upon request.





884595
eATLAS - box

NO-TOUCH MEANS LESS MICROORGANISMS.

Basically hold a hand above the tank to flush the water through the toilet.

Compatible with ceramic holes with 40mm or 50mm diameter.



eATLAS

Outlet valve with a universal sensor button that allows the regulation of the half and full flush volumes.



eDECO

Outlet valve with a universal and flexible application, allows the regulation of the half flush.



Electronic board. No electricity is required. When the battery is low, a LED flashes to alert the user that the batteries need to be replaced.



No-Touch technology is available in eDeco eAtlas outlet valves range. Activate the No-Touch by holding a hand above the tank to flush the water. Infrared sensor with a detection range of 0-50mm.





020863
AZOR PLUS side 3/8" brass - box

022369
ATLAS CABLE - bag

Allows the decentralization of the button in ceramics lids.



BETA

Highly reliable outlet valve secures the waste of water. The high standards of quality and outstanding raw materials (ABS) align with a through development join to furnish this outlet valve with a high discharge velocity bringing a high efficiency and cleanness to the toilet.



ATLAS

Atlas is a dual flush outlet valve with adjustable half and complete water flush volume. It has a universal top push button position that locks the ceramic lid.



ATLAS CABOS

Atlas Cable is a dual flush outlet valve with adjustable half and complete water flush volume. It is universal and flexible application (front, top or side push button position).



EASY ADJUSTMENT OF THE OVERFLOW PIPE

Universal adjustment according to the desired water level in different ceramic tanks with a telescopic overflow pipe.



EASY ADJUSTMENT OF THE FLUSH VOLUME

Residual adjustment of the half flush

Atlas allows you to adjust the half flush volume separately.

Residual adjustment of the complete flush

Slide the residual adjustment lever up and reduce the volume of the flush.

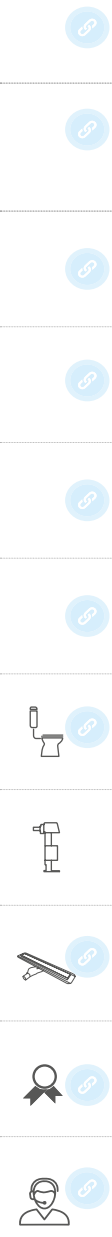

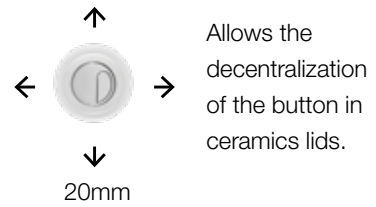

APOLO

This is a outlet valve with the most simple and quicker method of regulating the flush volumes and to install, being only require to, open the ceramic cistern lid, unlock the lever, adjust the height and lock the lever.



FAST START/STOP

Fast Start/Stop is a single flush outlet valve with start/stop system. It has a universal top push button position that locks the ceramic lid.

A



B



Adaptors included in the outlet valve FAST START/STOP. These adaptors are compatible with ROCA ceramic tanks and allow the replacement of the outlet valve without the need to remove the ceramic cistern.



PUSH ECO

Push Eco is a single flush outlet valve with universal top push button position.



ECO TIRETTE

Eco Tirette is a single flush outlet valve with universal top pull button position.



HANDLE

Handle is a single flush outlet valve with universal front handle button position.



TECHNICAL INFORMATION

OLI ONE

Inlet valve

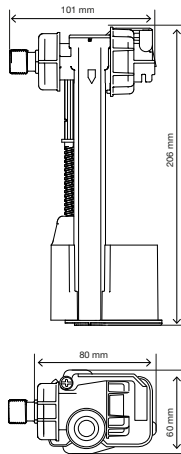

NANO PLUS

Inlet valve

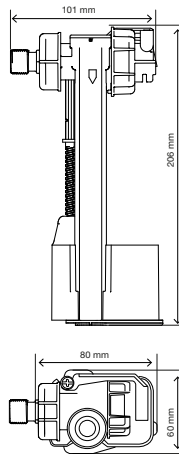

IVC102 PLUS

Inlet valve

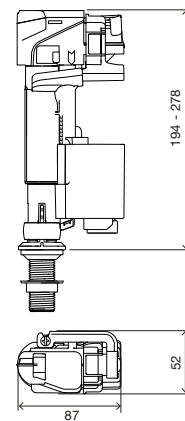

GENERAL FEATURES

- Compatible with in wall cisterns, exposed and ceramic tanks, adaptors for competitors compatibility;
- Side water connection with $\frac{3}{8}$ " brass or $\frac{3}{8}$ " plastic;
- Delayed refilling inlet valve: it starts after the outlet valve is in the close position;
- Silent inlet valve, class I;
- High performance on dirty waters;
- Counter pressure closing system (hydraulic), Effective with any flow pressure: Dynamic pressure functioning range: 0.5-10bar;
- Maximum static pressure: 16bar;
- Anti-backflow function;
- 10 year warranty.

GENERAL FEATURES

- Compatible with in wall cisterns, exposed and ceramic tanks;
- Side inlet valve with $\frac{3}{8}$ " brass;
- Delayed refilling inlet valve: it starts after the outlet valve is in the close position;
- Silent inlet valve, class I;
- High performance on dirty waters;
- Counter pressure closing system (hydraulic), Effective with any flow pressure: Dynamic pressure functioning range: 0.5-10bar;
- Maximum static pressure: 16bar;
- Anti-backflow function;
- 10 year warranty.

GENERAL FEATURES

- Quick filling;
- Bottom inlet valve with $\frac{1}{2}$ " brass, plastic or $\frac{15}{16}$ " in plastic connection;
- Delayed refilling inlet valve: it starts after the outlet valve is in the close position;
- Height adjustable;
- Silent inlet valve, class I;
- Integrated filter can be cleaned;
- Counter pressure closing system (hydraulic);
- Dynamic pressure functioning range: 0.5-6bar;
- Maximum static pressure: 16bar;
- Anti-backflow function;
- 10 year warranty.

AG104 PLUS

Inlet valve

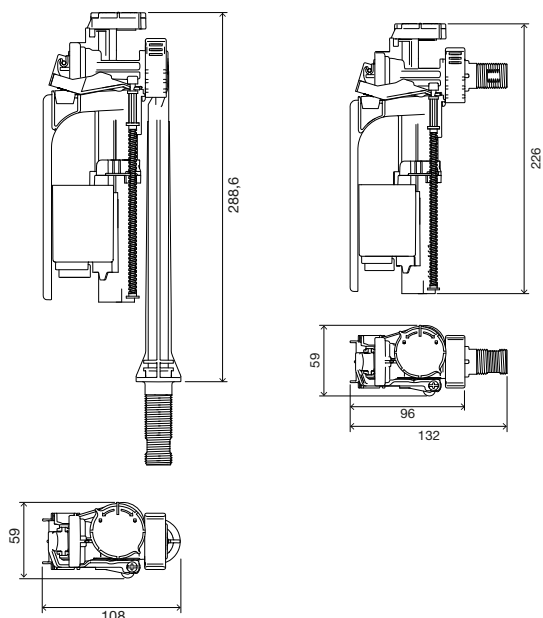

GENERAL FEATURES

- New back flow protection to prevent contamination;
- Compliant with UK standards;
- Compliant with, WRAS;
- Side or bottom water supply with 1/2" plastic connection;
- Delayed refilling inlet valve: it starts after the outlet valve is in the closed position;
- Easy maintenance without the need to disconnect from the water connection;
- Counter pressure closing system (hydraulic);
- Dynamic pressure functioning range: 0.1 – 10 bar;
- Maximum static pressure: 16 bar;
- 10 year warranty.

AZOR PLUS

Inlet valve

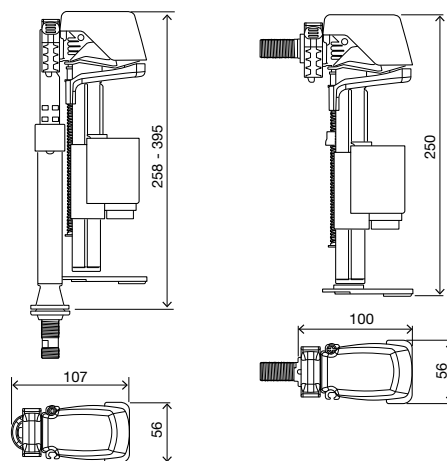

GENERAL FEATURES

- Delayed refilling inlet valve: it starts after the outlet valve is in the closed position;
- Side or bottom water supply with 3/8" brass and 1/2" plastic or brass;
- Adjustable height in the bottom connection;
- Counter pressure closing system (hydraulic);
- Dynamic pressure functioning range: 0.1 – 14 bar;
- Maximum static pressure: 20 bar;
- Silent valve class I;
- Easy maintenance without the need to disconnect from the water connection;
- Anti-Backflow function;
- Some versions compliant with, KIWA and DVGW, UPC, NF (side version);
- 10 year warranty.

UNI BOTTOM

Inlet valve

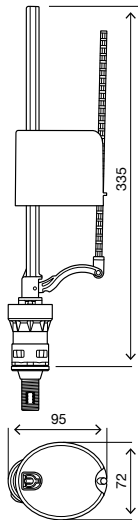

GENERAL FEATURES

- Bottom inlet valve, with $\frac{3}{8}$ " or $\frac{1}{2}$ " in brass or plastic connection;
- Piston closing system (Mechanical);
- Dynamic pressure functioning range: 0.5 – 8 bar;
- Maximum static pressure: 10 bar;
- 10 year warranty.

IVC100 PLUS

Inlet valve

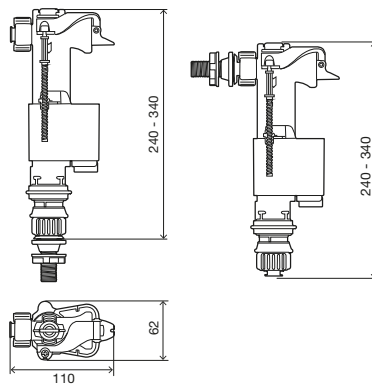
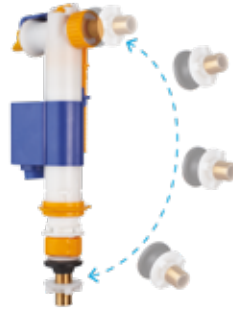

GENERAL FEATURES

- Side or bottom water supply connection in the same inlet valve;
- Integrated filter that can be cleaned without removing the water connection;
- Delayed refilling inlet valve: it starts after the outlet valve is in the close position;
- Side and bottom inlet valve, with $\frac{3}{8}$ " brass;
- Adjustable height in the bottom connection;
- Counter pressure closing system (hydraulic);
- Dynamic pressure functioning range: 0.1 – 10 bar;
- Maximum static pressure: 16bar;
- Easy maintenance, no need to disconnect water connection;
- Anti-backflow function;
- 10 year warranty.

AZOR SILENT

Inlet valve

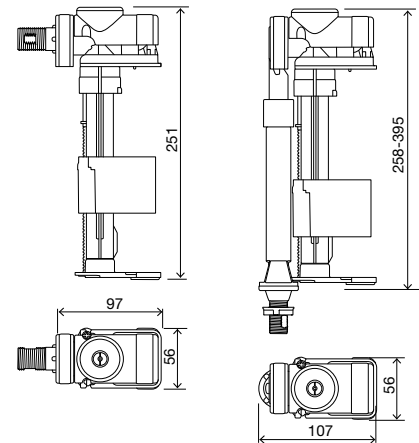

GENERAL FEATURES

- Silent inlet valve <6dB, NF class I certified;
- Side or bottom water supply in the same inlet valve with $\frac{3}{8}$ " or $\frac{1}{2}$ " brass or plastic connection;
- Height is adjustable with the bottom connection;
- Counter pressure closing system (hydraulic);
- Dynamic pressure functioning range: 0.1 – 14 bar;
- Maximum static pressure: 20 bar;
- Anti-Backflow function;
- Some versions compliant with: NF (side version in brass connection);
- 10 year warranty.

COMPACT

Inlet valve

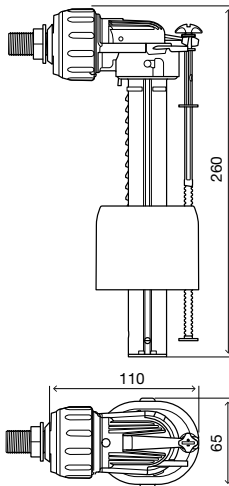

GENERAL FEATURES

- Side inlet valve, with $\frac{3}{8}$ " or $\frac{1}{2}$ " plastic or brass connection;
- Reduced dimensions;
- Silent valve, class I;
- Counter pressure closing system (hydraulic);
- Dynamic pressure functioning range: 0.1 – 10 bar;
- Maximum static pressure: 16 bar;
- Anti-Backflow function;
- Some versions compliant with: KIWA, NF;
- 10 year warranty.

JOLLY UNI

Inlet valve

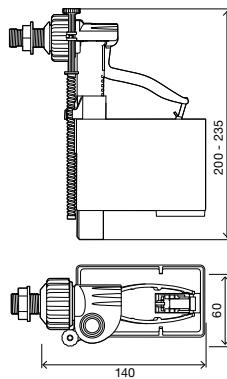

GENERAL FEATURES

- Piston closing system (Mechanical);
- Side inlet valve, with $\frac{3}{8}$ " or $\frac{1}{2}$ " brass or plastic connection;
- Silent valve, NF class I certified;
- Dynamic pressure functioning range: 0.5 – 10 bar;
- Maximum static pressure: 16 bar;
- Anti-Backflow function;
- Some versions compliant with: NF and KIWA;
- 10 year warranty.

ECO

Inlet valve

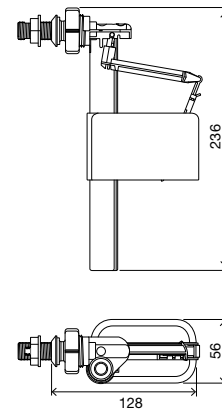

GENERAL FEATURES

- Piston closing system (Mechanical);
- Side inlet valve, with $\frac{3}{8}$ " or $\frac{1}{2}$ " plastic connection;
- Dynamic pressure functioning range: 0.5 – 8 bar;
- Maximum static pressure: 10 bar;
- Anti-Backflow function;
- 10 year warranty.

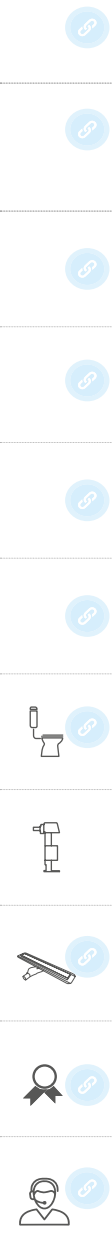

eATLAS

Outlet valve

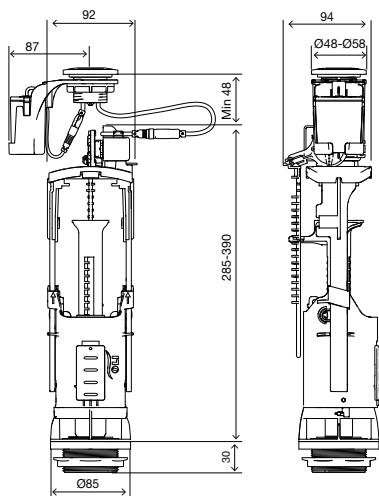

GENERAL FEATURES

- Outlet valve with sensor activation – safety, clean, health;
- Activation by sensor through the approach of the hand;
- Universal top button position;
- Dual flush system with different hand approach activation, both flushes are adjustable;
- Efficient flush with high flow rate;
- Telescopic overflow pipe;
- Easy and quick installation;
- Silicone seal;
- The system will be powered with 6 AA batteries;
- The battery holder has IP67 protection, can be positioned on the right or left side;
- Low battery warning LED;
- 2 years warranty for electronic components.

INCLUDED

- Ceramic cistern fixation system to the WC toilet;
- WC toilet seal foam (that compensates the ceramic irregularity);
- Chrome button sensor compatible with holes Ø38 and Ø50.

eDECO

Outlet valve

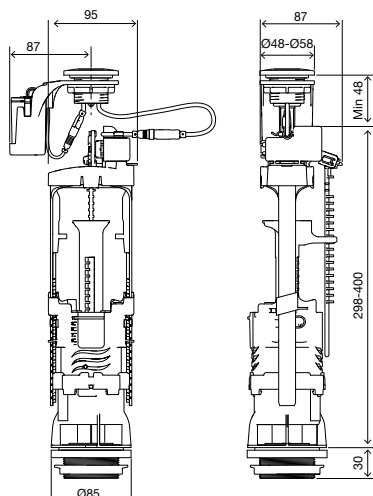

GENERAL FEATURES

- Outlet valve with sensor activation – safety, clean, health;
- Activation by sensor through the approach of the hand;
- Universal top button position;
- Dual flush system with different hand approach activation;
- Adaptor for older mechanism ceramic support;
- Efficient flush with high flow rate;
- Telescopic overflow pipe;
- Easy and quick installation;
- Silicone seal;
- The system will be powered with 6 AA batteries;
- The battery holder has IP67 protection, can be positioned on the right or left side;
- Low battery warning LED;
- 2 years warranty for electronic components

INCLUDED

- Ceramic cistern fixation system to the WC toilet;
- WC toilet seal foam (that compensates the ceramic irregularity);
- Chrome button sensor compatible with holes Ø38 and Ø50.

APOLO

Outlet valve

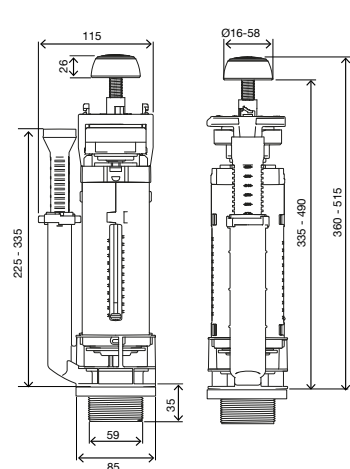

GENERAL FEATURES

- Dual flush outlet valve with adjustable half and complete water flush volume;
- Universal top push button position that locks the ceramic lid;
- Lateral overflow pipe, higher and easy adjustment;
- Lock/unlock system at the top, one step;
- Allows the off center of the button in ceramic lid 360° with 10° of inclination for each axis
- Mechanical actuation <20N;
- Efficient flush with high flow rate;
- Damping system – silent operation;
- Easy maintenance (bayonet system);
- Silicone seal;
- Compliant with: Watermark.

INCLUDED

- Ceramic cistern fixation to the WC toilet;
- WC toilet seal foam (that compensates the ceramic irregularity);
- Self-adjustable chrome push button with rosette for cisterns with lid holes from Ø16 to Ø60mm.

BETA

Outlet valve

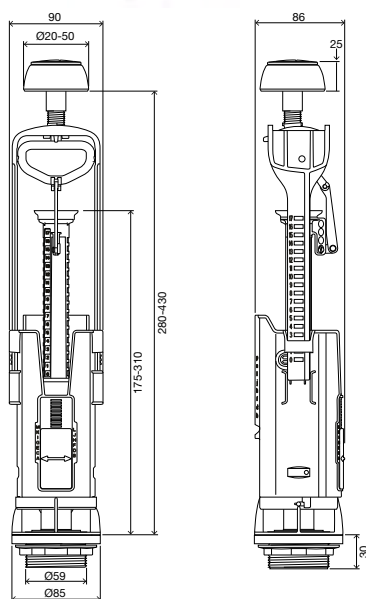

GENERAL FEATURES

- Dual flush outlet valve with adjustable half and complete water flush volume;
- Universal top push button position that locks the ceramic lid;
- Adjustable telescopic overflow pipe and adjustable lever height;
- Simpler adjustment of full / half flush;
- Efficient flush with high flow rate;
- Silent operation (damping system);
- According with NF.

INCLUDED

- Ceramic cistern fixation to the WC toilet;
- WC toilet seal foam (that compensates the ceramic irregularity);
- Self-adjustable chrome push button with rosette for cisterns with lid holes from Ø 16 to Ø 60mm.

ATLAS

Outlet valve

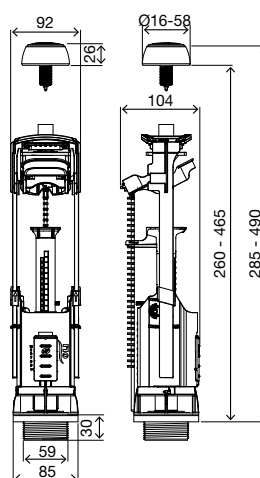

GENERAL FEATURES

- Dual flush outlet valve with adjustable half and complete water flush volume;
- Universal top push button position that locks the ceramic lid;
- Allows the off center of the button on the ceramic lid (25mm on each axis);
- Mechanical actuation <20N;
- Efficient flush with high flow rate;
- Damping system - silent operation;
- Adjustable telescopic overflow pipe and adjustable lever height;
- Silicone seal;
- Upon request some versions compliant with: NF, SAI.

INCLUDED

- Ceramic cistern fixation system to the WC toilet;
- WC toilet seal foam (that compensates the ceramic irregularity);
- Self-adjustable chrome push button with rosette for cisterns with lid holes from Ø16 to Ø60mm.

FAST START/STOP

Outlet valve

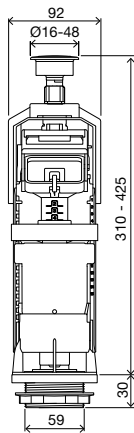

GENERAL FEATURES

- Single flush outlet valve with start/stop system;
- Universal top push button position that locks the ceramic lid;
- Allows the off center of the button on the ceramic lid (20mm on one axis);
- Mechanical actuation <20N;
- Efficient flush with high flow rate;
- Adjustable telescopic overflow pipe and adjustable lever height;
- Easy installation and maintenance (bayonet system);
- Adaptors for older mechanism ceramic support.

INCLUDED

- Ceramic cistern fixation system to the WC toilet;
- WC toilet seal foam (that compensates the ceramic irregularity);
- Self-adjustable chrome push button with rosette for cisterns with lid holes from Ø16 to Ø40mm.

ATLAS CABLE

Outlet valve

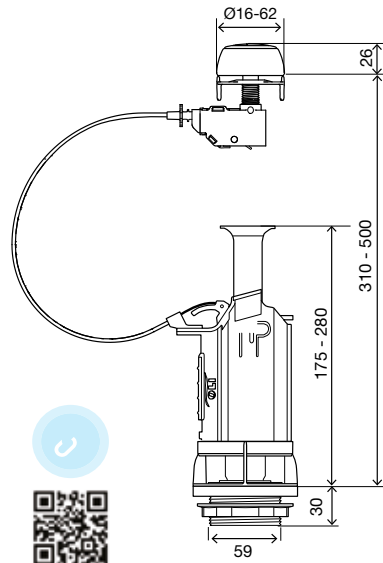

GENERAL FEATURES

- Dual flush outlet valve with adjustable half and complete water flush volume;
- Universal and flexible application (front, top or side push button position);
- Cable actuation < 20 N;
- Efficient flush with high flow rate;
- Damping system - silent operation;
- Adjustable telescopic overflow pipe;
- Silicone seal;
- Upon request some versions compliant with: NF;
- ONE PIECE version compatible with ONE PIECE toilets.

INCLUDED

- Ceramic cistern fixation system to the WC toilet;
- WC toilet seal foam (that compensates the ceramic irregularity);
- Self-adjustable chrome push button with rosette for cisterns with lid holes from Ø16 to Ø60mm.

PUSH ECO

Outlet valve

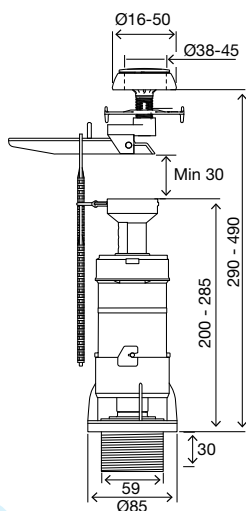

GENERAL FEATURES

- Single flush outlet valve;
- Universal top push button position;
- Mechanical actuation <20N;
- High flow rate flush;
- Adjustable telescopic overflow pipe;
- Easy installation and maintenance;
- EPDM seal.

INCLUDED

- Ceramic cistern fixation system to the WC toilet;
- WC toilet seal foam (that compensates the ceramic irregularity);
- Self-adjustable chrome push button with rosette for cisterns with lid holes from Ø16 to Ø50mm.

ECO TIRETTE

Outlet valve

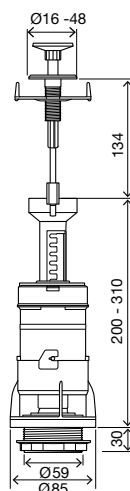

GENERAL FEATURES

- Single flush outlet valve;
- Universal top pull button position;
- Mechanical actuation <20N;
- High flow rate flush;
- Adjustable telescopic overflow pipe;;
- Easy installation and maintenance;
- EPDM seal.

INCLUDED

- Ceramic cistern fixation system to the WC toilet;
- WC toilet seal foam (that compensates the ceramic irregularity);
- Chrome pull button for cisterns with lid holes from Ø16 to Ø40mm.



HANDLE

Outlet valve

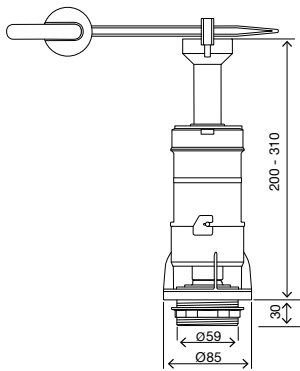

OLIPURE KIT

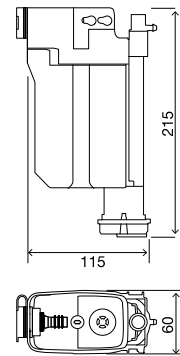

GENERAL FEATURES

- Single flush outlet valve;
- Universal front handle button position;
- Mechanical actuation <20N;
- High flow rate flush;
- Adjustable telescopic overflow pipe;
- Easy installation and maintenance;
- EPDM seal.

INCLUDED

- Ceramic cistern fixation system to the WC toilet;
- WC toilet seal foam (that compensates the ceramic irregularity);
- Chrome handle button for cisterns with Ø16 hole.

GENERAL FEATURES

- OLIPURE system;
- Azor side 3/8" brass connection;
- 350mm Refill connection pipe;
- 130mm Outlet valve connection pipe;
- Only suitable for ceramic cisterns with side connections and QUARZO exposed cistern.

ACCESSORIES



BATTERY SUPPORT

Battery support and holder for eATLAS and eDECO outlet valves.

CODE	DESCRIPTION
884728	Battery holder and support



BOTTOM COVER

- Cover for bottom connection ceramic tanks.

CODE	DESCRIPTION
058025	Bottom cover



SIDE COVER

- Cover for side connection ceramic tanks.

CODE	DESCRIPTION
493064	Side cover White
058340	Side cover Polished Chrome







AMBIWAVE





















- Liquid disinfectant for toilet;
- 450ml dosage;
- 12 units per pack.



CODE	DESCRIPTION
879955	Ambiwave-OLIpure

MECHANISMS KIT

















	BETA	ATLAS CABLE	PUSH ECO	FAST START STOP
NANO PLUS				
	885153 bag	-	-	-
IVC100 PLUS	-	099938 bag	-	-
UNI BOTTOM	-	883625 bag	501034 bag	013392 bag
ECO	-	-	501023 bag	-
COMPACT ASTRO	-	882003 bag	-	013393 bag

PART NUMBER GUIDE

	 Bottom water supply		 Side water supply		Upon request versions compliant with						
											
 OLI ONE	-		884379 3/8 brass/plastic box		-	-	-	-	-	-	-
 AG104 PLUS	883103 1/2" plastic bag		883099 1/2" plastic bag		●	-	-	-	●	-	-
 AZOR PLUS	020864(bottom) 3/8" brass box				-	●	●	●	-	●	●
			020863 (side) 3/8" brass box			●	●	●	-	●	●
 AZOR SILENT	002437 3/8" brass blister		●		-	●	-	-	-	-	-
 IVC100 PLUS	883706 3/8" brass box				-	-	-	-	-	-	-
	883818 3/8" brass bag				-	-	-	-	-	-	-
 IVC102 PLUS	879285 1/2" plastic bag		-		-	-	-	-	-	-	-
	878738 1/2" brass bag		-		-	-	-	-	-	-	-
	878737 15/16" plastic bag		-		-	-	-	-	-	-	-
 COMPACT	-	561460 3/8" brass box	-	-	-	●	●	-	-	-	-
	-	561598 3/8" brass bag	-	-	-	●	●	-	-	-	-
 JOLLY UNI	-	561460 3/8" brass box	560170 1/2" brass box		-	●	●	-	-	-	-
	-	044993 3/8" brass bag	044992 1/2" brass bag		-	●	●	-	-	-	-
 UNI BOTTOM	879622 3/8" brass bag	022371 1/2" brass bag			-	-	-	-	-	-	-
	5563571 3/8" plastic bag	044995 1/2" plastic bag			-	-	-	-	-	-	-
	562176 3/8" plastic box 092329 1/2" plastic box refill 562160 3/8" brass box	562163 1/2" plastic box 562162 1/2" brass box			-	-	-	-	-	-	-
 Eco	-	-	561058 3/8" plastic bag 561059 1/2" plastic bag		-	-	-	-	-	-	-
 OLIpure Kit	-	-	101768		-	-	-	-	-	-	-

 WxDxH	Weight	Qt.	 Multiple Box Dim	Weight	Qty per Pallet	Pallet Height	 Pallet Width	Pallet Length	Weight
151x71x261	0.3	30	595x391x500	10.2	600	2.65	0.8	1.2	300
260x0.07x460	0.3	50	595x391x500	14.5	1000	2.66	0.8	1.2	290
146x76x326	0.3	20	600x400x435	11.52	400	2.66	0.8	1.2	230
151x71x261	0.3	30	595x391x500	10.8	600	2.65	0.8	1.2	216
150x80x400	0.49	18	595x391x535	11.52	360	2.3	1	1.2	230.4
151x71x261	0.36	30	595x391x500	12.3	600	2.66	0.8	1.2	246
260x0.07x460	0.3	50	595x391x500	16.5	1000	2.66	0.8	1.2	330
260x0.07x460	0.2	35	595x391x500	0.29	700	2.66	0.8	1.2	203
260x0.07x460	0.3	35	595x391x500	0.33	700	2.66	0.8	1.2	231
210x0.03x330	0.24	35	595x391x250	10.15	700	1.41	0.8	1.2	203
151x71x261	0.29	30	595x391x500	10.5	600	2.65	0.8	1.2	210
260x0.07x460	0.23	60	595x391x500	15.6	1200	2.16	1	1.2	312
151x71x261	0.29	30	595x391x500	10.5	600	2.65	0.8	1.2	210
260x0.07x460	0.2	25	595x391x500	6.75	500	2.16	1	1.2	135
390x46x577	0.3	20	595x391x500	6	500	2.66	1	1.2	150
260x0.07x460	0.13	100	760x496x480	16	1200	2.1	1	1.26	192
260x0.07x460	0.13	100	760x496x480	16	1200	2.1	1	1.26	192
161x116x261	1.0843	17	595x391x500	18.36	340	2.160	800	1.200	367.2

PART NUMBER GUIDE

					compliance		
	Dual Flush	Single flush	Start/Stop	Dimensions			
eATLAS 	884595 box	-	-	288(H) 108 x 58 (W x D)	-	-	-
eDECO 	884593 box	-	-	288(H) 108 x 58 (W x D)	-	-	-
APOLO 	882794 bag 883098 box	-	-	288(H) 108 x 58 (W x D)	-	-	•
BETA 	883215 bag 884443 box	-	-	288(H) 108 x 58 (W x D)	•	-	-
ATLAS CABLE 	022369 bag 501120 box 880334 One piece bag	-	-	288(H) 108 x 58 (W x D)	•	-	-
ATLAS 	135948 bag 011967 box	-	-	288(H) 108 x 58 (W x D)	•	-	•
FAST STAR/STOP 	-	-	088755 bag 100019 box	288(H) 108 x 58 (W x D)	-	-	-
PUSH ECO 	-	501021 bag 501020 box	-	288(H) 108 x 58 (W x D)	-	-	-
TIRETTE ECO 	-	500321 bag 011662 box	-	288(H) 108 x 58 (W x D)	-	-	-
HANDLE 	-	501420 box	-	288(H) 108 x 58 (W x D)	-	-	-

WxDxH	Weight	Qt.	Multiple Box Dim	Weight	Qty per Pallet	Pallet Height	Pallet Width	Pallet Length	Weight
119x105x355	0.5663	20	595x391x500	325.8	500	2.66	1	1.2	325.8
121x121x371	0.55	12	595x391x500	6.6	240	2.66	0.8	1.2	135
300x0.07x550	0.62	30	595x391x500	20.253	600	2.66	0.8	1.2	405.06
121x121x371	0.6987	20	595x391x535	13.982	320	2.3	0.8	1.2	223.712
300x0.07x550	0.44	26	595x391x500	11.44	520	2.66	0.8	1.2	270.4
119x105x355	0.44	20	595x391x500	8.8	320	2.16	0.8	1.2	165.3
300x0.07x550	0.3825	30	595x391x500	13.473	480	2.16	0.8	1.2	215.568
595x391x500	-	20	119x105x311	11.2	400	2.66	0.8	1.2	224
300x0.07x550	0.39	30	595x391x500	11.7	480	2.16	0.8	1.2	187.2
300x0.07x550	0.4656	26	595x391x500	280.176	520	2.66	0.8	1.2	280.176
119x105x355	0.5663	20	595x391x500	325.8	500	2.66	1	1.2	325.8
300x0.07x550	0.472	20	595x391x500	224.12	400	2.16	1	1.2	224.12
121x121x371	0.5727	12	595x391x500	171.456	240	2.66	0.8	1.2	171.456
119x105x311	0.405	20	595x391x500	195.32	400	2.16	1	1.2	195.32
119x105x311	0.3993	20	595x391x500	241.25	500	2.66	1	1.2	241.25
119x105x311	0.3842	20	595x391x500	230.15	500	2.66	1	1.2	230.15
119x105x311	0.3804	20	595x391x500	230.75	500	2.66	1	1.2	230.75
119x105x311	0.3971	20	595x391x500	240.1	500	2.66	1	1.2	240.1

OLIFILO







300301
OLIFILO premium 80

170

OLIFILO

Shower systems built into the floor or wall allowing for greater ease of cleaning and design in the bathroom.

OLIFILO is OLI range of shower drains, available in multiple sizes for floor or wall installation. The support legs allow for a height adjustment of the shower drain in order to adapt it, to the different installation requirements and depth. Stainless steel grates with a refined design available in lengths between 400mm to 1100mm.

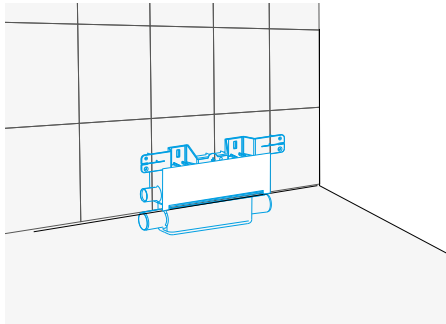

WALL

An innovative wall shower drainage system with an elegant stainless steel grate, which allows to enjoy the entire shower space. Easy to install and maintain, it is the ideal solution for the shower.

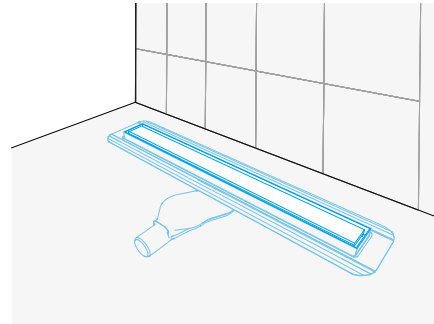

FLOOR

A floor-even shower with an elegant stainless steel grate that allows you to enjoy the whole shower space. With different grates sizes available, easy to install and maintain, makes it the ideal solution for any shower.





OLIFILO X-WALL

The grate is fully accessible in order to ease as much as possible cleaning and maintenance operations. X-Wall can be installed in any type of wall and in prefabricated MFV systems, and it will make the bathroom modern, linear and safe.





OLIFILO CERAMIC

Possibility of tiling the grate with the same covering as the bathroom floor. A floor-even shower drain with a stainless steel grate allows the maximum space in the shower. Olifilo Ceramic has a 360° polypropylene siphon, with a grate prepared for ceramic finish (10mm ceramic thickness).





OLIFILO PREMIUM

A floor-even shower drain with an elegant stainless steel grate with a frame that allows to enjoy the whole shower space. Easy to install and maintain and 360 rotating siphon and the high flow rate, Olifilo Premium it is the ideal solution for the shower. The grate with frame is in brushed stainless steel.



OLIFILO STANDARD

A floor-even shower drain with a standard stainless steel grate with a frame that allows to enjoy the shower space. With different grates sizes available between 700mm and 1100mm and 360 rotating siphon, Olifilo Standard is the ideal solution for the shower. The grate with frame is in stainless steel.





OLIFILO BASIC

A floor-even shower drain with a stainless steel grate with a frame that allows to enjoy the shower space. This range offers different grates between 400mm to 700mm and includes an ABS plastic shipon with vertical or horizontal connection.



OLIFILO SQUARE

Square floor-even shower drain system with a minimalist design thanks to its reduced dimensions. Olifilo Square includes a 360° polypropylene siphon and a stainless steel body.

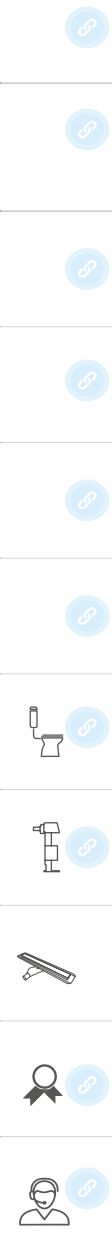

OLIFILO X-WALL

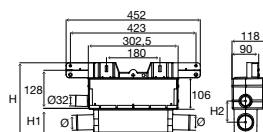
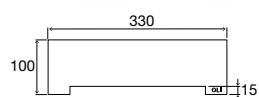

H	H1	H2
242	89,5	71

OLIFILO CERAMIC

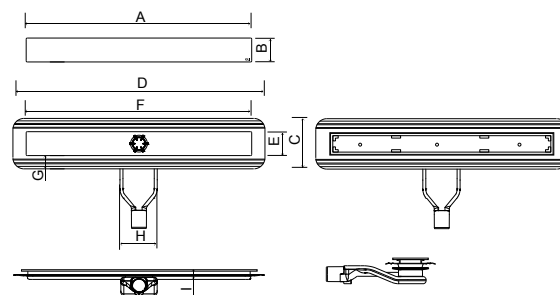

A	B	C	D	E	F	G	H	I
800	60	135	875	64	804	35	100	73

GENERAL FEATURES

- Minimum required installation height: 70 mm;
- Integrated A/C condensation drainage system;
- Pre-assembled waterproofing membrane;
- Excellent flow: 0,6 l/s (36 l/min);
- Excellent smell resistance 290 Pa (200 Pa required);
- Support coupling devices.

GENERAL FEATURES

- Stainless steel body, grid for a ceramic finish;
- Easy to install and maintain;
- Ideal for people with reduced mobility.

OLIFILO PREMIUM

OLIFILO STANDARD

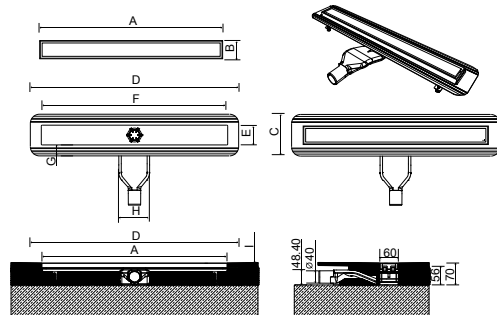
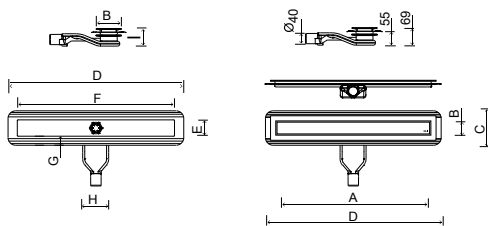

A	B	C	D	E	F	G	H	I
836	96	135	875	64	804	35	100	70
936	96	135	975	64	904	35	100	70

A	B	C	D	E	F	G	H	I
700	60	135	775	64	704	35	100	70
800	60	135	875	64	804	35	100	70
900	60	135	975	64	904	35	100	70
1100	60	135	1175	64	1104	35	100	70



GENERAL FEATURES

- Stainless steel body, grid with frame in brushed stainless steel;
- Easy to install and maintain;
- Ideal for people with reduced mobility.

GENERAL FEATURES

- Stainless steel body, smooth grid in brushed stainless steel;
- Easy to install and maintain;
- Ideal for people with reduced mobility.

OLIFILO BASIC

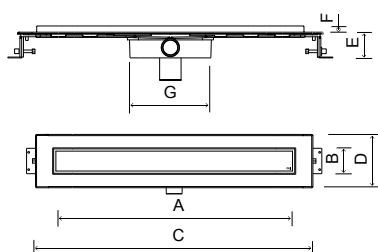

A	B	C	D	E	F	G	H	I
403	66	488	132	72	14	197	Ø40	Ø50
603	66	688	132	72	14	197	Ø40	Ø50
703	66	788	132	72	14	197	Ø40	Ø50
803	66	888	132	72	14	197	Ø40	Ø50

GENERAL FEATURES

- Stainless steel body, grid in shiny stainless steel satin;
- Easy to install and maintain;
- Ideal for people with reduced mobility;
- Support legs included.

OLIFILO SQUARE

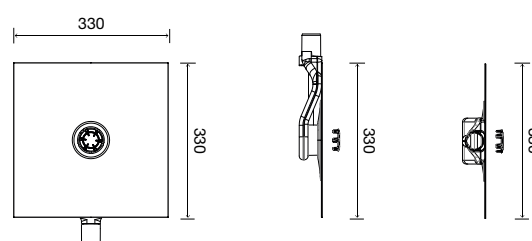
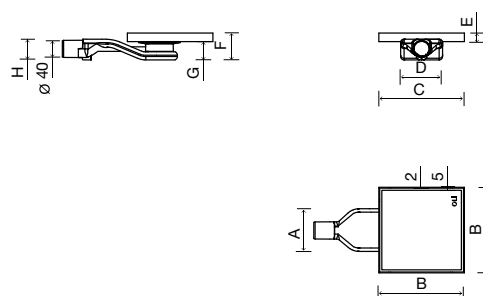

A	B	C	D	E	F	G	H
100	200	200	98	20	63	43	48

GENERAL FEATURES

- Square siphon shower drain in brushed stainless steel 20x20;
- Easy to install and maintain;
- Ideal for people with reduced mobility.

ACCESSORIES



SUPPORT LEGS

- Available for Premium, Standard and Ceramic OLIFLO.







CODE	DESCRIPTION
300300	Support legs



NOTES

A series of horizontal dashed lines for writing notes.



PART NUMBER GUIDE

	FLOOR	WALL	SUPPORT LEGS	20 mm	30 mm	40 mm	50 mm	60 mm	70 mm	80 mm	90 mm
OLIFILO PREMIUM 	●	-	300300	-	-	-	-	-	-	300301	-
OLIFILO STANDARD 	●	-	300300	-	-	-	-	-	300310	300312	300314
OLIFILO CERAMIC 	●	-	300300	-	-	-	-	-	-	300330	-
OLIFILO BASIC 	●	-	-	-	-	300341	-	300340	300347	300342	-
OLIFILO X-WALL 	-	●	-	-	000201	-	-	-	-	-	-
OLIFILO SQUARE 	●	-	-	300360	-	-	-	-	-	-	-

									
WxDxH	Weight	Qt.	Multiple Box Dim	Weight	Qty per Pallet	Pallet Height	Pallet Width	Pallet Length	Weight
160x920x140	6	-	-	-	96	1850	850	1250	307
160x920x140 /70/80 160x1180x140 /90	3.4	-	-	-	96-70/80 55 90"	1850	950 70/80 800 90"	1250 70/80 1200 90"	288/70 330/80 191/90
160x920x140	4	-	-	-	96	1850	950	1250	375
150x150x560 /40 160x690x140 /60x 160x850x140 /70 160x920x140 /80	0,920/40 1.05/60 1.65/70 1.75/80	-	-	-	120/40 112/60 96/70 96/80	800/40 850/60 900/70 950/80	120/40 125/60/70/80	185/40/60/70/80	120/40 117/60 158/70 168/80
475x265x155	1.5	-	-	-	98	2400	800	1200	158
130x420x240	2	-	-	-	240	1850	1000	1200	409



WARRANTY TERMS

1. WARRANTY PERIODS for OLI products:

- a. In-wall flushing cisterns, bidet, washbasin and urinal frames - 10 (ten) years;
- b. Exposed flushing cisterns - 5 (five) years;
- c. Flushing mechanisms (inlet valves and outlet valves) - 10 (ten) years;
- d. Electronic components, fixtures, and fast-wearing parts, specifically rubber seals or similar products, push-buttons and flush plates - 2 (two) years;
- e. All other products - 2 (two) years;

2. The warranty period starts on the purchase date by the first final Consumer. The sales document, corroborating the sales date of the OLI product and the respective serial number, certifies the start date of the warranty. In the event of a subsequent purchase, or any alteration in proprietorship or user, the warranty period shall continue for the remainder of the warranty period and shall continue unaltered relative to all other aspects of the warranty.

3. This warranty is also applicable to subsequent substitution parts for those determined to be defective until the end of the warranty period for the product of which they are a part, or up to two years after their application if the remaining warranty period for the product is less than two years. The repair or substitution of a product or a part does not renew the initial warranty period.

4. This warranty is only valid if the product has been correctly installed, in accordance with the installation instructions and the information contained in the catalogues and manuals provided by OLI. In situations where information is not covered in the aforementioned resources, installation should be carried out in accordance with the standards, rules and technical specifications contained in the legislation in effect, applicable to the type of devices and mechanisms in question. Before being sold, products must be stored in a dry place.

5. The applicability of this warranty also depends on the use considered to be normal for the products, the operating conditions (ex. pressure, temperature, etc.) and the type of liquid used, which should have values within the parameters indicated in the catalogues or manuals provided by OLI.

6. If the flush pipes are used for other liquids other than network water, the standards relative to the resistance of polyethylene (PE), polypropylene (PP) and polyvinyl chloride (PVC) should always be respected.

7. Products with missing parts or which are defective at the time of installation, as well as during pressure tests, should not be used.

8. OLI products should not be used with other products which do not have local national Quality Approvals/Certificates.

9. Any product return should be accompanied by a copy of the sales receipt, with the product in its original packaging, whenever possible.

10. This warranty is immediately terminated and is not extended to any equipment or part that has been damaged or become inoperative as

a result of the following:

- a) Accident, fall, fire, flooding and inappropriate, abusive or negligent use;
- b) Use of parts or accessories which have not been manufactured or provided by OLI, or whose provision and/or manufacture have not been expressly authorised by OLI;
- c) Unauthorised alterations to the equipment;
- d) Breaking of any warranty seal or removal of any label with the serial number or legally mandatory marking;
- e) Assistance, repairs or substitutions carried out by third parties other than OLI, an authorised reseller or certified technical centre.

11. Under no circumstances does the warranty cover the product's installation.

12. The products are packaged in duly identified packages which fulfil the requirements established in applicable national legislation. OLI cannot be held responsible for material or personal damage resulting from the incorrect or inappropriate use of the packages.

13. Failure to comply with any of the aforementioned clauses releases OLI from responsibilities pertaining to material damage and/or non-material damage which may result.

14. OLI recommends that the packaging materials of its products, after no longer being needed, should be recycled by the appropriate and socially responsible means and processes.

15. In the case of defects or non-conformity of OLI products, a written notification should be sent to the sales representative or OLI client manager within 60 days of becoming aware of the defect, as long as it was not previously visible, within reason. The appropriate measure shall then be taken to determine the possible defects detected. The notification may also occur by telephone, followed by a registered letter with acknowledgment of receipt within 24 hours to Customer Service, OLI - Sistemas Sanitários, S.A., Travessa do Milão, Esgueira, 3800-314 Aveiro (Portugal)

16. Failure to comply with the terms of the aforementioned number may result in the total or partial loss of the right to compensation or of the warranty itself.

17. The notification mentioned in Point 15 of this Warranty, issued by means of registered letter to OLI's Customer Service should contain the following information:

- a) Name, address and telephone number of the claimant;
- b) Identification of the product;
- c) Entity and place where the product was acquired (when not at OLI), as well as the respective purchase date;
- d) Address of the location where the product was installed;
- e) Description of the visible losses;
- f) Type of installation and the materials used (if the claimant has this information);
- g) Conditions of use, ex. type of system, pressure, temperature, etc. (if the claimant has this information);
- h) Name, address and telephone number of the company or person who installed the product.

18. Any personal information provided shall be used solely for processing the claim and for contact with the claimant and may be transmitted to the insurance provider to which civil responsibility for damages has been transferred.

19. Any obligation to repair, substitute, reduce the price or reimburse, if this should be the case, shall occur only for OLI products which have a visible marking or identifying logotype, with defects or non-conformities which have been proved through extensive technical verification. If it is concluded that the product is not defective, the expenses paid by OLI shall be invoiced to the claimant. The product's technical standards at the time of its manufacture shall be the basis for its conformity assessment.

20. OLI cannot be directly held responsible by the purchaser if the product's non-conformity results from actions by the resellers (or other commercial agents) of OLI products, namely when non-conformity results from statements made by the sales representative regarding the product, its qualities and use conditions, which are different from the product's indications and instructions, including the information contained in manuals and instruction guides provided with the products or published on the company's website.

21. The consumer's rights and obligations are established in the Legal Regime for the Sale and Warranty of Consumer Goods (Law-Decree No 67/2003, of 8th April, and its subsequent alterations, specifically those foreseen by Law-Decree No 84/2008, of 21st May), as well as the Consumer Protection Act (Law No 24/96, of 31st July).

22. Any litigation resulting from the terms or interpretation of the present warranty, or of the purchase and sales contract from which the warranty results, is regulated by Portuguese law and resolved in the court of the competent legal jurisdiction where the headquarters of the warranty provider, OLI, are located, with express waiver of any other, except in cases where OLI and the beneficiary of the warranty have agreed to settle the litigation in an arbitration court.

23. This warranty binds OLI according to its exact terms, except typographical errors.



ONLINE SUPPORTS

CUSTOMER SUPPORT

Always contact OLI support through phone or e-mail

OLI provides phone contact +351 234 300 200 and email export@oli-world.com to provide a close accompaniment throughout the year for every project.



BIM

OLI is committed to be at the forefront of development in the construction sector.

BIM is the new standard of construction and facilitates the transfer of information between stakeholders and enables integrated management throughout the product life cycle.



COLORADD

Innovation and Social Vanguard

OLI is the first sanitary systems company in the world to adopt ColorADD, a unique, universal and transversal code that allows colour blind people to correctly identify colours.

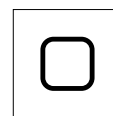

White



Black
Black Soft Touch



Matt chrome
Chrome



Anthracite
Grey Soft Touch



Red



Taupe



Gold



Polished Chrome

OLI ON SOCIAL MEDIA

Follow all OLI updates and news



OLI TECH

OLI TECH was developed for smartphone and tablet to provide direct access to useful information for professionals.

Get quick access to technical data sheets, assembly instructions, maintenance videos and products characteristics that OLI offers to market.

Download OLI TECH through the QR-CODES and give feedback to: communication@oli-world.com

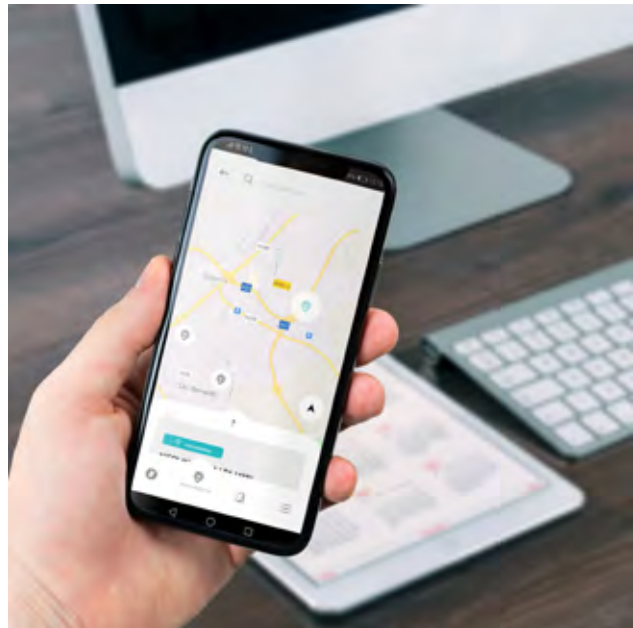

FAVOURITES



DISTRIBUTORS



REPLACEMENT PARTS



FEEDBACK



NEW PRODUCTS



Virtual showroom:

www.oli-world.com/en/services-/showroom-360-/sanitary-systems

SHOWROOM 360°

Presents several solutions for sustainable flushing systems, dual flush flush plates and mechanisms for all types of walls and toilets.

Browse and discover all the innovative and sustainable solutions in a configuration that brings you closer to the real installation.

Discover new products and find all the necessary information in an intuitive way!

C.0050.07-02.2021
ZB030000000015



OLI-Sistemas Sanitários, S.A.
Travessa do Milão, Esgueira
3800-314 Aveiro, Portugal

T (+351) 234 300 200
F (+351) 234 300 212
www.oli-world.com
export@oli-world.com

Inspired by water...